

Order From
 Dick Jones Sales, Inc.
 258 Baltimore St. PO Box 141
 Hanover, PA 17331
 Phone 800-441-9955
 Fax 800-253-4036
 dickjones@dickjonesales.com

LOADING DOCK EQUIPMENT

SUPPLEMENT 112



DOCK LEVELERS



DOCK SEAL & SHELTERS

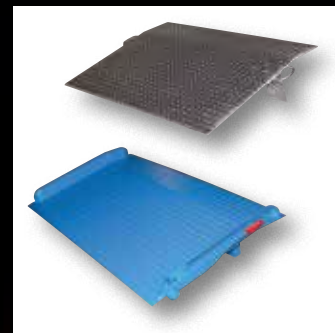

DOCKPLATES & DOCKBOARDS



WHEEL CHOCKS



TRAILER STABILIZING JACKS



DOCK BUMPERS

Truck Scissor Dock Lifts	A2-A3
Dock Levelers	A3-A5
Dock Seals and Dock Shelters	A8-A9
Yard Ramps	A12-A13
Dockplates and Dockboards	A14-A18
Wheel Risers	A19
Walk & Service Ramps	A20-A22
Hose & Cable Bridges	A23-A26
Loading Lights	A26-A27
Cargo Bars & Strapping	A28-A29
Wheel Chocks & Accessories	A30-A32
Trailer Stabilizing Jacks	A34
Dock Bumpers	A34-A36
Prylever Bars	A37



Shown with
Optional Aluminum Bridge
(one steel bridge standard)



Premium Truck Scissor Dock Lifts

Save time and reduce man-hours where there are no docks with a Truck Scissor Dock Lift. The pit or surface mount has an optional approach ramp. Engineered and designed for maximum safety and efficiency. The diamond plate deck is made of heavy gauge steel for years of use. Hydraulic cylinders feature emergency velocity fuse if line breaks. It comes complete with upper travel limit switch and overload relief valve. The push button control is on a 20 foot long coil cord. Pre-wired control box includes magnetic starter with overload relay. High visibility safety yellow removable handrails with fixed toe boards are standard. Includes beveled toe-guards and electric toe-guards around perimeter of platform. Standard external 6.5 HP 460V, 3-phase, 60 Hz motor can be located up to 8 feet away from lift (weighs 300 lbs.) **460V 3-PHASE STD, OPTIONS ON PG. A3**

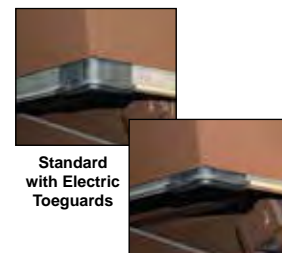

Standard
with Electric
Toe-guards

OPTIONS

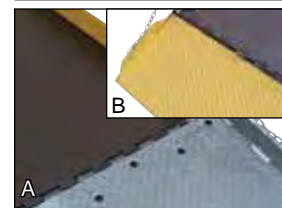

A) ALUMINUM BRIDGE • WL-SATB
B) STEEL BRIDGE • WL-SSTB



REMOVABLE HANDRAIL
AND TOEBOARDS
model WL-RHT



STOP SIGNAL SIGN
model WL-SSS



COLD GALVANIZED COATING

MODEL NUMBER	PLATFORM SIZE (W x L)	LOWERED HEIGHT	RAISED HEIGHT	UNIFORM CAPACITY (LBS.)	OVERALL FRAME SIZE (W x L)	NET WT. (LBS.)
WL-100-5-48	48" x 96"	8"	68"	5,000	41" x 93"	3125
WL-100-5-68	72" x 96"	8"	68"	5,000	62" x 93"	3485
WL-100-5-78	84" x 96"	8"	68"	5,000	62" x 93"	3706
WL-100-5-88*	96" x 96"	8"	68"	5,000	86" x 93"	3957
WL-100-5-610	72" x 120"	8"	68"	5,000	62" x 118"	3828
WL-100-5-710	84" x 120"	8"	68"	5,000	62" x 118"	4032
WL-100-5-810*	96" x 120"	8"	68"	5,000	86" x 118"	4112
WL-100-6-68	72" x 96"	10"	70"	6,000	62" x 93"	3648
WL-100-6-78	84" x 96"	10"	70"	6,000	62" x 93"	3793
WL-100-6-88*	96" x 96"	10"	70"	6,000	86" x 93"	4172
WL-100-6-610	72" x 120"	10"	70"	6,000	62" x 118"	3944
WL-100-6-710	84" x 120"	10"	70"	6,000	62" x 118"	4043
WL-100-6-810*	96" x 120"	10"	70"	6,000	86" x 118"	4306
WL-100-8-68	72" x 96"	10"	70"	8,000	62" x 93"	4401
WL-100-8-78	84" x 96"	10"	70"	8,000	62" x 93"	4597
WL-100-8-88*	96" x 96"	10"	70"	8,000	86" x 93"	4703
WL-100-8-610	72" x 120"	10"	70"	8,000	62" x 118"	4812
WL-100-8-710	84" x 120"	10"	70"	8,000	62" x 118"	4918
WL-100-8-810*	96" x 120"	10"	70"	8,000	86" x 118"	5162
WL-100-10-68	72" x 96"	14"	72"	10,000	62" x 93"	5809
WL-100-10-78	84" x 96"	14"	72"	10,000	62" x 93"	5996
WL-100-10-88*	96" x 96"	14"	72"	10,000	86" x 93"	6182
WL-100-10-610	72" x 120"	14"	72"	10,000	62" x 118"	6042
WL-100-10-710	84" x 120"	14"	72"	10,000	62" x 118"	6229
WL-100-10-810*	96" x 120"	14"	72"	10,000	86" x 118"	6410
WL-100-10-612	72" x 144"	14"	72"	10,000	62" x 118"	6509
WL-100-10-712	84" x 144"	14"	72"	10,000	62" x 118"	6695
WL-100-10-812*	96" x 144"	14"	72"	10,000	86" x 118"	6881
WL-100-12-68	72" x 96"	14"	72"	12,000	62" x 93"	6392
WL-100-12-78	84" x 96"	14"	72"	12,000	62" x 93"	6578
WL-100-12-88*	96" x 96"	14"	72"	12,000	86" x 93"	6736
WL-100-12-610	72" x 120"	14"	72"	12,000	62" x 118"	6625
WL-100-12-710	84" x 120"	14"	72"	12,000	62" x 118"	6812
WL-100-12-810*	96" x 120"	14"	72"	12,000	86" x 118"	6998
WL-100-12-612	72" x 144"	14"	72"	12,000	62" x 118"	7103
WL-100-12-712	84" x 144"	14"	72"	12,000	62" x 118"	7230
WL-100-12-812*	96" x 144"	14"	72"	12,000	86" x 118"	7441

*Units 96" wide cannot ship LTL. These sizes will need to ship flat bed.

Premium Truck Scissor Dock Lift Options

SPLIT ALUMINUM TRUCK BRIDGE: Ideal for government applications. 72"W x 18"L. For 5 & 6K units. (110 lbs. add'l bridge) Replacement of standard steel bridge. **Model WL-SATB.**
Additional split aluminum bridge. **Model WL-ADDSATB.**

SPLIT STEEL BRIDGE: Split Steel Bridge that can be added to the opposite side of the Truck Scissor Dock Lift. 72" wide x 18" long. (180 lbs. add'l bridge) **Model WL-SSTB.**

REMOVABLE HANDRAILS/TOEBOARDS: Used on a Truck Scissor Dock Lift that is mounted in a pit. This allows the platform to be flush with the floor for fork truck cross traffic. Please deduct 7½ (in.) from overall width for usable width. **Model WL-RHT.**

WARNING BEEPER & STROBE: Sounds and flashes during the lifting and lowering operations on a Truck Scissor Dock Lift. 80 decibels. **Model WL-WB.**

ADDITIONAL HYDRAULIC LINE: Allows you to locate power unit further away from the lift. 8 foot of hose is standard. **Model WL-HH-(LENGTH).**

APPROACH RAMP FOR 8" LOWERED HEIGHT: 60" wide x 65" long. 7° ramp angle. 397 lbs. **Model WL-AR8.**

APPROACH RAMP FOR 10" LOWERED HEIGHT: 60" wide x 82" long. 7° ramp angle. 517 lbs. **Model WL-AR10.**

APPROACH RAMP FOR 14" LOWERED HEIGHT: 60" wide x 116" long. 7° ramp angle. 788 lbs. **Model WL-AR14.**

APPROACH RAMPS MUST BE ANCHORED TO THE FLOOR

Premium Truck Scissor Dock Lift Options

50,000 lbs. ROLLOVER CAPACITY (25,000 lbs. per axle): Adds additional structural channel supports for the deck. Increases lowered height 2". **Model WL-50.** (adds 400 lbs. to 6 x 8 units)

MOBILE WHEEL KIT: Kit may be used on the 5,000 and 6,000 lbs. capacity units only. System includes casters and handle. (400 lbs.) **Model WL-WK.**

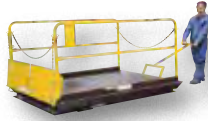

SPECIAL RESERVOIR MOUNTING: Available in a wall mount or a handrail mount (non-removable). **Model WL-RMB.**

AUTOMATIC WHEEL CHOCKS: Block the dock end of ramp to avoid roll off as the unit lifts. This system requires a special pit mount. **Model WL-AWC.**



STOP SIGNAL SIGN: Optional Stop Sign Signal that raises up to let the driver know when to stop for safe loading/unloading. This is only available on surface mount units with fixed toe boards. **Model WL-SSS.** (reduces usable width by 2")

PROTECTIVE CANOPY: Fits 6' x 8' platforms. Measures 108" high. Steel construction. Bolt-on installation. Custom sizes available, contact factory. **Model WL-CANOPY.**

KEY SWITCH LOCKOUT: Avoids unauthorized use of the lift. This option will lock out the controls at the power unit. **Model WL-KL.**

TWO SPEED PUMP: Increase lifting speed by 55% when lift is unloaded. Ideal for unloading applications. **Model WL-TSP.**

2 HP SINGLE- OR THREE- PHASE ELECTRIC MOTOR: 2 HP single phase motor that is available in an internal power unit. Pumps about 1 gallon per minute. **Model WL-2HP.**

3 HP SINGLE PHASE ELECTRIC MOTOR: Replace standard three phase power unit with 208/230V, 1 phase, 60Hz power unit (approx.: 1½ gallons per minute pump speed). **Model WL-3HP.**

7-1/2 HP POWER UNIT: Power unit is wired for three phase 208-230/460V 60Hz, unit will pump approximately 6 gallons per minute. **Model WL-7HP.**

10 HP POWER UNIT: Power unit is wired for three phase 208-230/460V 60Hz, unit will pump approx. 8 gallons/min. **Model WL-10HP.**

COLD GALVANIZED LIQUID COATING: For application usage visit www.zrcworldwide.com **Model SPO-WL-LS-ZRC.**

STEEL-IT™ COATING: Visit www.steel-it.com for application usage. **Model SPO-WL-LS-SSC.**

IMMERSION OIL HEATER: For cold weather applications with a built in metal reservoir & thermostat for automatic heat control. 208-230V single or three (3) phase power, 250 watts. This option can only be used in steel tanks. **Model IOH-230V.**

Use with 460V 3 phase power unit, 500 watts. **Model IOH-460V.**

Truck Actuated Dock Levelers

- 55,000 psi high strength checker plate deck
- 12" long lip (extends 6½" into truck)
- Toeguards on each side
- Service range of 14" above through 8" below dock
- (2) Molded Bumpers; 5"W x 16"H x 6"D
- Lift By-Pass for Safety

This is a fully automatic loading ramp where there is no dock attendant needed. It consists of a lift by-pass for safety and toe guards on each side. As the truck backs against the twin actuating arms (bumpers) it pushes the carriage back. As the carriage goes back the deck goes up. When the carriage bumpers contact the dock, the deck floats down to rest on the trailer. When the truck pulls out, the deck returns to level supported position automatically.



RECESSED DOCK LEVELER series RU

MODEL NUMBER	DESCRIPTION	UNIFORM CAPACITY	NET WT. (LBS.)
RU-600-SCB	6'W x 6'L Recessed Unit, Standard 28" Deep Pit	20,000	2310
RU-800-SCB	6'W x 8'L Recessed Unit	20,000	2520
RU-800-SCB-F	6'W x 8'6"L Recessed Unit	20,000	3045
RU-1000-SCB	6'W x 10'L Recessed Unit	20,000	3150
SU-600-SCB	6'W x 6'L Recessed Unit with Legs, Full 48" Deep Pit	20,000	2149
SU-800-SCB	6'W x 8'L Recessed Unit with Legs	20,000	2730
SU-800-SCB-F	6'W x 8'6"L Recessed Unit with Legs	20,000	3255
SU-1000-SCB	6'W x 10'L Recessed Unit with Legs	20,000	3360
PU-600-SCB	6'W x 6'L (Dock Leveler Unit with Legs for in Front of Dock Placement)	20,000	2194
PU-800-SCB	6'W x 8'L (Dock Leveler Unit with Legs for in Front of Dock Placement)	20,000	3045
PU-1000-SCB	6'W x 10'L (Dock Leveler Unit with Legs for in Front of Dock Placement) (SPECIFY DOCK HEIGHT WHEN ORDERING)	20,000	3675



DOCK LEVELER WITH LEGS FOR FRONT OF DOCK PLACEMENT series PU

TRUCK ACTUATED DOCK LEVELER OPTIONS

MODEL NUMBER	DESCRIPTION	NET WT. (POUNDS)
WS-DV	DUAL VINYL WEATHER STRIPPING (FACTORY INSTALLED)	--
CAS	CURB ANGLE SET (FOR ANY SIZE DOCKLEVELER)	242
TA-30K/6	30,000 POUND CAPACITY FOR 6 FOOT LENGTH	--
TA-30K/8	30,000 POUND CAPACITY FOR 8 FOOT LENGTH	--
TA-30K/10	30,000 POUND CAPACITY FOR 10 FOOT LENGTH	--
7W/6	7 FOOT WIDTH FOR 6 FOOT LENGTH	230
7W/8	7 FOOT WIDTH FOR 8 FOOT LENGTH	253
7W/10	7 FOOT WIDTH FOR 10 FOOT LENGTH	299
FI	FOAM INSULATION	6
TL	NOTCH FOR TRAILER LOCK	--
SPO	SHALLOW PIT OPTION (minimum depth 24")	--
BE	BUMPER EXTENSION FOR LOW DOCKS	--

CAPACITIES TO 100,000 POUNDS AVAILABLE - CONTACT FACTORY



HEAVY-DUTY SPRINGS HELP LIFT THE DECK WHEN A TRUCK COMES INTO CONTACT WITH THE DOCKLEVELER

DOCK LEVELER SURVEY SHEET CAN BE FOUND ON PAGE A38



RATCHET CONTROL AND ACTUATION SPRINGS



EASY OPERATION

Mechanical Dock Levelers

The Mechanical Dock Leveler is constructed of heavy duty ¼" diamond plate deck (55,000 PSI) steel to support the understructure for long life. The dock leveler allows for easy truck loading and unloading. The leveler is engineered and designed for minimum maintenance and features a smooth pull chain operation. Lip is 16" long. Service range 12" above and below dock. Includes (2) 1014-4.5 laminated bumpers. Uniform capacities available up to 50,000 pounds.



MODEL NUMBER	OVERALL SIZE WITH LIP	OPERATION	UNIFORM CAPACITY (LBS.)	NET WT. (POUNDS)
RR-65	6'W x 5'4"L	Pull Chain	20,000	1445
RR-66	6'W x 6'4"L	Pull Chain	20,000	1680
RR-68	6'W x 8'4"L	Pull Chain	20,000	2051
RR-610	6'W x 10'4"L	Pull Chain	20,000	2550
RR-75	7'W x 5'4"L	Pull Chain	20,000	1632
RR-76	7'W x 6'4"L	Pull Chain	20,000	1955
RR-78	7'W x 8'4"L	Pull Chain	20,000	2682
RR-710	7'W x 10'4"L	Pull Chain	20,000	2930

Electric Hydraulic Dock Levelers 460V 3-PHASE STD, OPTIONS ON PG. C2

The Electric Hydraulic Dock Leveler is ideal for high usage dock areas. The hydraulic design consists of a simple push of the button operation. The operator pushes and holds the "raise" button which activates the hydraulic pump and raises the deck. When the deck reaches the raised position the lip automatically extends. The operator releases the "raise" button and the deck descends to rest on the trailer. The control box includes a red emergency stop button standard. When the truck pulls away, the deck descends to full down position, trips the limit switch, and returns automatically to the level cross traffic position. Includes telescopic steel toe guards on both sides, flush with platform edge, service range of +/- 12", and two (2) 1014-4.5 laminated bumpers. Uniform capacities available up to 80,000 pounds.



MODEL NUMBER	OVERALL SIZE WITH LIP	OPERATION	UNIFORM CAPACITY (LBS.)	NET WT. (LBS.)
EH-65	6'W x 5'4"L	ELECTRIC HYDRAULIC	20,000	1346
EH-66	6'W x 6'4"L	ELECTRIC HYDRAULIC	20,000	1599
EH-68	6'W x 8'4"L	ELECTRIC HYDRAULIC	20,000	1890
EH-610	6'W x 10'4"L	ELECTRIC HYDRAULIC	20,000	2310
EH-75	7'W x 5'4"L	ELECTRIC HYDRAULIC	20,000	1501
EH-76	7'W x 6'4"L	ELECTRIC HYDRAULIC	20,000	2000
EH-78	7'W x 8'4"L	ELECTRIC HYDRAULIC	20,000	2300
EH-710	7'W x 10'4"L	ELECTRIC HYDRAULIC	20,000	2940



CONTROL BOX



STATE-OF-THE-ART HYDRAULIC DESIGN



DOCK LEVELER SURVEY SHEET CAN BE FOUND ON PAGE A38

MECHANICAL & ELECTRIC HYDRAULIC DOCK LEVELER OPTIONS		
MODEL NUMBER	DESCRIPTION	NET WT. (POUNDS)
WS-DV	DUAL VINYL WEATHER STRIPPING PRE-INSTALLED	--
ES	EMERGENCY STOP (RR-SERIES ONLY)	54
CAS	CURB ANGLE SET (PIT SIZE REQUIRED AT TIME OF ORDER)	242
SPO	SHALLOW PIT OPTION (17½" MINIMUM DEPTH)	--
FI	UNDER-DECK FOAM INSULATION	6
18"LIP/6	18" LONG LIP FOR 6' WIDE DOCK LEVELER	31
18"LIP/7	18" LONG LIP FOR 7' WIDE DOCK LEVELER	36
30K/6	30,000 POUND UNIFORM CAPACITY FOR 6' LENGTH	--
30K/8	30,000 POUND UNIFORM CAPACITY FOR 8' LENGTH	--
30K/10	30,000 POUND UNIFORM CAPACITY FOR 10' LENGTH	--
FOD/6'	LEG OPTION FOR IN FRONT OF DOCK PLACEMENT (6' LENGTH)	240
FOD/8'	LEG OPTION FOR IN FRONT OF DOCK PLACEMENT (8' LENGTH)	240
FOD/10'	LEG OPTION FOR IN FRONT OF DOCK PLACEMENT (10' LENGTH)	240
SS/65	STEEL SHELL FOR 6' x 5' POUR IN PLACE INSTALLATION	218
SS/66	STEEL SHELL FOR 6' x 6' POUR IN PLACE INSTALLATION	285
SS/68	STEEL SHELL FOR 6' x 8' POUR IN PLACE INSTALLATION	290
SS/610	STEEL SHELL FOR 6' x 10' POUR IN PLACE INSTALLATION	298
SS/75	STEEL SHELL FOR 7' x 5' POUR IN PLACE INSTALLATION	238
SS/76	STEEL SHELL FOR 7' x 6' POUR IN PLACE INSTALLATION	252
SS/78	STEEL SHELL FOR 7' x 8' POUR IN PLACE INSTALLATION	264
SS/710	STEEL SHELL FOR 7' x 10' POUR IN PLACE INSTALLATION	277
CWO	COLD WEATHER OIL - GOOD TO -50°F (ELECTRIC DOCK LEVELER)	8
EH-TL*	ELECTRIC INTERLOCK (EH DOCK LEVELER & TRAILER RESTRAINT)	-

*TRAILER RESTRAINT SOLD SEPARATELY
20" LIP RECOMMENDED FOR REFRIGERATED TRUCKS

Edge-O-Dock Levelers

The Edge-O-Dock Leveler permanently attaches to face of dock. It is recommended for docks to be at least forty-eight (48) inches high. When the trailer departs, the lip drops automatically behind the face of the bumpers. Concrete recess is not required. It comes complete with 2" x 8" x 18" bumpers and installation instructions. Standard ramping is twenty-seven (27) inches, with a thirty-six (36) inch long ramping length available for smaller grade. A steel dock edge, or approach ramp is required for proper installation.

The **Mechanical Edge-O-Dock** is operated by placing the actuation handle into the pocket of the inner lip and pulling down toward the floor. The operator then pushes the handle forward until the lip rests on the truck bed. As the trailer departs, the lip retracts behind the bumper face automatically.

The **Hydraulic Hand Pump** system is used to lift the leveler and extend the lip. The operator rotates the relief valve allowing the deck to descend down and rest upon the trailer. Unit comes complete with hand pump, wall-mount brackets, cylinder, 15 feet of hydraulic line and oil. Truck must pull out for leveler to return to stored position.

The **Electric Hydraulic Edge-O-Dock** is the easiest to operate. After the truck is backed against the dock, push and hold the control button. The leveler raises and the lip will extend. 115V, 1 phase power standard. Unit comes complete with motor, pump, control box, cylinder, lines, and oil. Truck must pull out for leveler to return to stored position.

48 Hours
to Ship

New



MECHANICAL • series FM



HYDRAULIC HAND PUMP
series PP

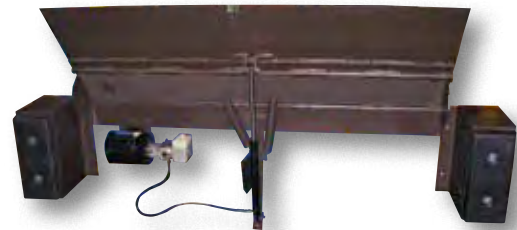

ELECTRIC HYDRAULIC • series PE

115V 1-PHASE STD, OPTIONS ON PG. C2

MODEL NUMBER	OPERATION	**USABLE WIDTH	UNIFORM CAPACITY (LBS.)	NET WT. (LBS.)
FM-0648	MECHANICAL	48"	6,000	348
FM-2066	MECHANICAL	66"	20,000	514
FM-2072	MECHANICAL	72"	20,000	523
FM-2078	MECHANICAL	78"	20,000	583
FM-2566	MECHANICAL	66"	25,000	556
FM-2572	MECHANICAL	72"	25,000	575
FM-3066	MECHANICAL	66"	30,000	663
FM-3072	MECHANICAL	72"	30,000	709
PP-1572-36*	HAND PUMP	72"	15,000	752
PP-2066	HAND PUMP	66"	20,000	583
PP-2072	HAND PUMP	72"	20,000	627
PP-2566	HAND PUMP	66"	25,000	622
PP-2572	HAND PUMP	72"	25,000	671
PP-2572-36*	HAND PUMP	72"	25,000	1168
PP-3066	HAND PUMP	66"	30,000	998
PP-3072	HAND PUMP	72"	30,000	1061
PE-1572-36*	ELECTRIC	72"	15,000	749
PE-2066	ELECTRIC	66"	20,000	581
PE-2072	ELECTRIC	72"	20,000	601
PE-2566	ELECTRIC	66"	25,000	682
PE-2572	ELECTRIC	72"	25,000	702
PE-2572-36*	ELECTRIC	72"	25,000	940
PE-3066	ELECTRIC	66"	30,000	745
PE-3072	ELECTRIC	72"	30,000	782

*DENOTES 36" RAMPING LENGTH FOR SMALLER GRADE

**OVERALL WIDTH IS USABLE WIDTH PLUS 26"

OPTIONAL STEEL FACE FOR BUMPER, model EOD-SF

EDGE-O-DOCKLEVELER OPTIONS		
MODEL NUMBER	DESCRIPTION	NET WT. (POUNDS)
FM-HOOK	PULLING HOOK FOR MECHANICAL UNIT (OLD STYLE)	3
FM-BAR	ACTUATION HANDLE FOR MECHANICAL UNIT (NEW STYLE)	8
BB	STEEL BUMPER BOX	75
B-818	RUBBER BUMPER (REPLACEMENT), 18"W x 8"H x 2"P	16
FM-FM	FM-SERIES (HOOK STYLE) TO FM-SERIES (HANDLE STYLE) CONVERSION KIT	12
FM-PP	FM-SERIES TO PP-SERIES CONVERSION KIT	53
FM-PE	FM-SERIES TO PE-SERIES CONVERSION KIT	89
PP-PE	PP-SERIES TO PE-SERIES CONVERSION KIT	56
CE	CURB EDGE - 6" CHANNEL x 96" LONG	90
RAMP-2	APPROACH RAMP 96"W x 12"L x 2"H	120
RAMP-4	APPROACH RAMP 96"W x 24"L x 4"H	215
AP	APPROACH PLATE ¼" THICK x 12"L x 96"W	132
AP-BE	APPROACH PLATE ¼" THICK x 12"L x 96"W WITH BEVELED EDGE	130



CONTROL BOX

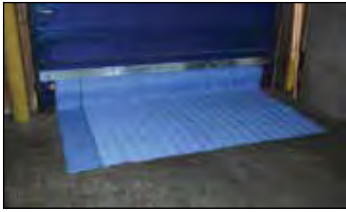

Dock Leveler Insulation Blanket

The Dock Leveler Insulation Blanket helps improve heating efficiency while using less energy. Prevents cold air from entering your warehouse from cracks that surround the dock door and leveler. The blanket includes aluminum extrusion, anchors, and hangers that fit most standard doors. The hangers allow for a secure raised blanket position. The blanket will pay for itself many times over by controlling heat loss.

MODEL NUMBER	OVERALL SIZE (W x L)	DESCRIPTION	NET WT. (POUNDS)
DIB-96 [®]	90" x 96"	INSULATION BLANKET	17



Weather Stripping (for pit mounted dock levelers)



The dock leveler Weather Stripping keeps out pests and rodents and maintains the proper working environment. The kit includes: (2) pre-cut side strips, (1) pre-cut foam insulator for the rear of the pit, and installation hardware.

The Dual Vinyl has a white dual-seal that attaches to the side of dock levelers with self-tapping sheet metal screws. The replacement vinyl slides into extruded channel that is attached with self-tapping screws.

The easy install Brushes bolt on to the aluminum extrusion sides of the lever then simply slide brushes into aluminum extrusion channel.



DUAL VINYL • series WS-DV

DUAL VINYL	MODEL NUMBER	LENGTH (PIT / STRIP)
	WS-5-DV [®]	50" / 41"
	WS-6-DV [®]	62" / 53"
	WS-8-DV [®]	85" / 77"
	WS-10-DV [®]	110" / 101"

REPLACEABLE VINYL	MODEL NUMBER	LENGTH (PIT / STRIP)
	WS-5-RV [®]	50" / 42"
	WS-6-RV [®]	62" / 54"
	WS-8-RV [®]	85" / 78"
	WS-10-RV [®]	110" / 102"



BRUSH • series WS-RB

1" REPLACEABLE BRUSH	MODEL NUMBER	LENGTH (PIT / STRIP)
	WS-5-RB-1 [®]	50" / 42"
	WS-6-RB-1 [®]	62" / 54"
	WS-8-RB-1 [®]	85" / 78"
	WS-10-RB-1 [®]	110" / 102"

1-1/2" REPLACEABLE BRUSH	MODEL NUMBER	LENGTH (PIT / STRIP)
	WS-5-RB-1.5 [®]	50" / 42"
	WS-6-RB-1.5 [®]	62" / 54"
	WS-8-RB-1.5 [®]	85" / 78"
	WS-10-RB-1.5 [®]	110" / 102"

Trailer Lock Systems 115V 1-PHASE STD, OPTIONS ON PG. C2

The Trailer Lock System is designed for installation directly in front of the loading dock. The electric hydraulic system captures the ICC bar on the back of semi-trailers. To ensure maximum safety the unit comes standard with an accumulator that allows the lock to follow the trailer up and down as it is loaded/unloaded. A beeper and flashing light warns the operator if the lock does not engage the trailer properly. A visual indication of the restraint's status is shown at all times by the traffic light outside and the control panel inside. It comes standard with light package, control panel, and three (3) large visual signs. Draw pull shear strength is 32,000 pounds.

MODEL NUMBER	DESCRIPTION	NET WT. (POUNDS)
TL-100-F	Electric Hydraulic, Aluminum Light Pkg. 115V, 1 PH	470
TL-100-F-S	Electric Hydraulic, Polypropylene Light Pkg. 115V, 1 PH	518
TL-100-F-S-LED	Electric Hydraulic, Polypropylene LED Light Pkg. 115V, 1 PH	518
TL-200-HP-F	Hand Pump Hydraulic, Aluminum Light Package	405
TL-200-HP-F-S	Hand Pump Hydraulic, Polypropylene Light Pkg.	495

Dock Traffic Systems 115V 1-PHASE STD, OPTIONS ON PG. C2

Our Dock Traffic Systems feature flashing red and green lights. Prevent accidents and injuries by providing clear communication between dock personnel and truck drivers. Built-in eyebrow type sun visors increase light visibility. LED model never needs bulb replacements.

Deluxe, model DTS-10, consists of one (1) yellow aluminum traffic light with both a green and red lens (for outside), and an illuminated push-button control (for inside). Light measures 14"W x 21 3/4"H and features an 8" hood over each lens (recommended for west and south exposure). 60 Watt. 115V AC. Four (4) procedure signs are included.

Economy, model DTS-5, comes with two (2) yellow polypropylene traffic lights, 6 1/2"W x 11 1/2"H, each having a green and a red lens. The light containing a push button is placed inside the dock area for the dock attendant, and the other is placed outside for the truck driver. Four (4) signs are included.

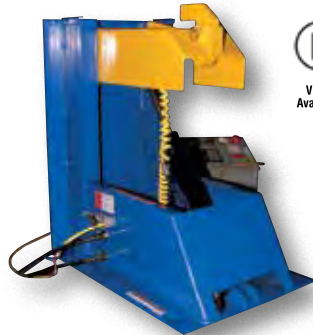

ALUMINUM DTS-10 POLYPROPYLENE DTS-5 LED LIGHTS DTS-5-LED

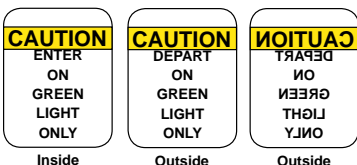

MODEL NUMBER	DESCRIPTION	INCLUDES	NET WT. (LBS.)
DTS-10 [®]	Aluminum Housing	Lights, (4) Signs, Control Panel	30
DTS-5 [®]	Polypropylene Housing	Lights, (4) Signs, 115V, 1 Phase	9
DTS-5-LED	LED Lights	Lights, (4) Signs, 115V, 1 Phase	8

Dock Barricades - Designed to Prevent Loading Dock "Run Off's" 115V 1-PHASE STANDARD

The Dock Barricade represents the next generation of innovative loading dock safety systems. The electric/hydraulic power unit provides quick and effortless operation. It can stop a four thousand (4,000) pound loaded truck at four (4) miles per hour. It is electronically operated and consists of an electrical bumper-style safety stop circuit to sense obstructions when lowering. Installation is simple, anchor the unit to the floor, mount the control on the wall and plug in. Mechanical unit, model DJG-100MW, features a manual hand crank winch to raise/lower barricade arm.



MECHANICAL • DJG-100MW

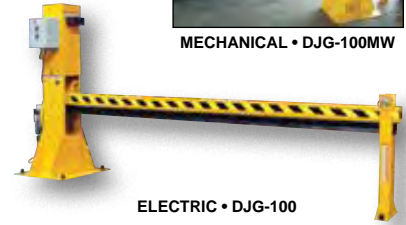

ELECTRIC • DJG-100

MODEL NUMBER	DOOR SIZE	OVERHEAD CLEARANCE	ARM HEIGHT LOWERED	OVERALL (W x L)	NET WT. (POUNDS)
DJG-100*	8' x 8'	150"	28½"	24" x 129 ⁷ / ₈ "	754
DJG-100-10*	10' x 10'	180"	28½"	24" x 155"	765
DJG-100MW	8' x 8'	149"	28"	24" x 133¼"	780

*ELECTRIC HYDRAULIC POWERED UNITS

Safety Lift Gates

Simply lift and the self folding action folds the gate in a vertical position. With the assistance of the air assist cylinder the gate can be lifted with the slightest effort. The Lift Gate is manufactured of steel tubing with a corrosion resistant coating. Unit can be either wall or floor mounted. Ideal on loading dock doors to help reduce the possibility of people falling.

MODEL NUMBER	LENGTH	BASE PLATE	HEIGHT	VERTICAL HEIGHT WHEN FOLDED	NET WT. (POUNDS)
SLG-6	6'	6"	43"	111"	23
SLG-10	10'	6"	43"	159"	33

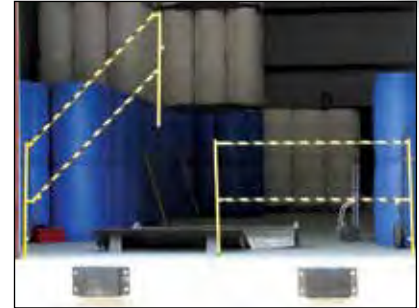

TWO SIX FOOT SECTIONS SHOWN

Economical Safety Swing Gate

An economical way to protect people from dock falls. Durable railings are constructed from schedule 40 pipe (1¼" O.D.). Units have a top rail height of 46¼" and a 25" mid-rail. 4" hard rubber wheel allows units to be swung out of the way. Foot release lock keeps the railing from being moved when in use. Cast single socket is included. Powder coat yellow finish.



MODEL NUMBER	MATERIAL	OPENING WIDTH	HEIGHT	NET WT. (POUNDS)
SSG-9	STEEL	108"	46¼"	105
SSG-11	STEEL	132"	46¼"	138



Dock Chain Bollard Barrier System

The Dock Chain Bollard Barrier creates a safe environment for both personnel and products. The steel constructed double chain design adds extra security for doors up to 10'. Unit is designed with a safety yellow finish for clear visibility, and a bolt on chain hook-up enabling a quick installation or removal. Chains are mounted at 21" and 42" high on the bollard and the chain can be cut to size upon request. Series DCBB-42 include two (2) bollards, two (2) 127" long chains and one (1) DCBB-B-KIT. Concrete anchor hardware available separately. Model DCBB-B-KIT is for use with existing bollards. Kit includes two (2) bollard mounting brackets, two (2) clips for chain and hardware.

MODEL NUMBER	OVERALL HEIGHT	BOLLARD DIAMETER	ACCOMMODATES DOOR SIZE	NET WT. (POUNDS)
DCBB-42-4.5	42"	4.5"	10 FOOT	80
DCBB-42-5.5	42"	5.5"	10 FOOT	84
DCBB-B-KIT	BOLLARD CONVERSION KIT			2
BOL-CHAIN	3/16" STEEL POWDER COAT CHAIN (SOLD PER FOOT)			30
AS-344-4PK	ANCHOR BOLTS FOR CONCRETE (4) 3/4" x 4 1/4"			4



Swivel Dock Gate

The Swivel Dock Gate is ideal for securing platforms or pathways. The gate features a steel construction for durability and a yellow powder coat finish for clear visibility. An attachable swing stop is added to the base of each bollard to reduce the wing length of gate arms, and to change the direction of gate swing. A chain slot is also attached to the end of each gate arm for the option of added security. All models come in pairs. Units have pre-drilled mounting holes for easy installation.

MODEL NUMBER	ACCOMMODATES DOOR SIZE	OVERALL HEIGHT	BOLLARD DIAMETER	NET WT. (LBS.)
SDG-8	8 foot	41½"	5½"	150
SDG-9	9 foot	41½"	5½"	170
SDG-10	10 foot	41½"	5½"	190
AS-344-4PK	ANCHOR BOLTS FOR CONCRETE (4) 3/4" x 4 1/4"			4



SECURE GATE IN OPEN OR CLOSED POSITION WITH PADLOCK (NOT INCLUDED).



series D-150

**DOCK SEAL & SHELTER
SURVEY SHEET IS
ON PAGE A39**

Dock Seals

The superior 36 oz. nylon reinforced vinyl facing has a higher tear strength than equivalent weight hypalon. The chemically sealed ends prevent moisture infiltration. It is mounted on and bonded to a durable wolmanized wood and contains a full height air escape tunnel. The unit consists of a three (3) piece construction (12" high; sides - beveled sides with 9½" width at the wall and 12" width at the face) and a through the wall installation kit that is included. 5" maximum compression is recommended. Application with a flush dock to building in conjunction with an Edge-O-Dock use a twenty (20) inch projection Dock Seal. To ensure proper size complete and fax the survey sheet shown on page A39. Units are non-returnable.

MODEL NUMBER	PROJECTION	OVERALL HEIGHT	OVERALL WIDTH	NET WT. (POUNDS)
DOOR SIZE 8 FEET WIDE x 8 FEET HIGH				
D-150-10	10"	108"	120"	212
D-150-11	11"	108"	120"	214
D-150-12	12"	108"	120"	216
D-150-13	13"	108"	120"	218
D-150-14	14"	108"	120"	219
D-150-15	15"	108"	120"	220
D-150-16	16"	108"	120"	221
D-150-17	17"	108"	120"	222
D-150-18	18"	108"	120"	249
D-150-19	19"	108"	120"	251
D-150-20*	20"	108"	120"	252

*USE IN CONJUNCTION WITH EDGE-O-DOCK LEVELER



series D-350

MODEL NUMBER	PROJECTION	OVERALL HEIGHT	OVERALL WIDTH	NET WT. (POUNDS)
DOOR SIZE 8 FEET WIDE x 9 FEET HIGH				
D-350-10	10"	120"	120"	216
D-350-11	11"	120"	120"	218
D-350-12	12"	120"	120"	220
D-350-13	13"	120"	120"	225
D-350-14	14"	120"	120"	237
D-350-15	15"	120"	120"	243
D-350-16	16"	120"	120"	248
D-350-17	17"	120"	120"	250
D-350-18	18"	120"	120"	264
D-350-19	19"	120"	120"	270
D-350-20*	20"	120"	120"	275

*USE IN CONJUNCTION WITH EDGE-O-DOCK LEVELER



series D-150/650

Dock Seal/Shelter Combinations

The Dock Seal/Shelter Combination is used with a 96"W x 120"H door. The top header is constructed of wolmanized lumber and is built with a slope to allow for water run-off. Header measures 114"W with a 30"L drop curtain. Side (verticals) measure 120" tall and contain high density foam mounted to treated lumber. The verticals are mounted on wooden boards (the face of the vertical measures 12"W and tapers to 9½" at wall) allowing wall mounting down the length of the vertical pieces. Application with flush dock to building in conjunction with an Edge-O-Dock use a 20" projection Dock Seal. To ensure proper size complete and fax the survey sheet shown on page A39. Units are non-returnable.

- Effective sealing action with full height access.
- This versatile unit utilizes seal sides and a shelter top.



**DOCK SEAL & SHELTER
SURVEY SHEET IS
ON PAGE A39**

MODEL NUMBER	PROJECTION	OVERALL HEIGHT	OVERALL WIDTH	NET WT. (POUNDS)
DOOR SIZE 8 FEET WIDE x 10 FEET HIGH				
D-150/650-10	10"	126"	114"	271
D-150/650-11	11"	126"	114"	278
D-150/650-12	12"	126"	114"	285
D-150/650-13	13"	126"	114"	287
D-150/650-14	14"	126"	114"	290
D-150/650-15	15"	126"	114"	293
D-150/650-16	16"	126"	114"	296
D-150/650-17	17"	126"	114"	298
D-150/650-18	18"	126"	114"	299
D-150/650-19	19"	126"	114"	302
D-150/650-20*	20"	126"	114"	305

*USE IN CONJUNCTION WITH EDGE-O-DOCK LEVELER

Dock Shelters

The Dock Shelter is used with doors up to 10'W x 10'H. The dock shelter reduces oversized doors to match truck openings. The long wear fabric is highly resistant to abrasion and tearing. Fiberglass staves are sewn into the flaps. Seal is formed along the sides and top of trailer when the vertical and top panels are pushed inward by the trailer. Recommend minimum 10" trailer penetration for a good seal. Supporting structure is made of 2" x 4" wolmanized lumber. The top header piece measures 132"W and contains a drop curtain which measures 36"H. Two vertical pieces measure 126" tall with vertical flaps measuring 21"W. When installed, the shelter will close the door opening down to 90"W x 90"H (between flaps). Includes two yellow steel guide protectors and foam-filled corner pads for extra sealing action. To ensure proper size complete and fax the survey sheet shown on page A39. Units are non-returnable.

MODEL NUMBER	PROJECTION	OVERALL HEIGHT	OVERALL WIDTH	NET WT. (POUNDS)
DOOR SIZE 8 FEET WIDE x 8 FEET HIGH to 10 FEET WIDE x 10 FEET HIGH				
D-750-18	18"	126"	132"	418
D-750-24	24"	126"	132"	478
D-750-30	30"	126"	132"	518
D-750-36	36"	126"	132"	563



DOCK SEAL & SHELTER SURVEY SHEET IS ON PAGE A39

Retractable Dock Shelter

The Retractable Dock Shelter fits up to a 120"W x 120"H door. Independent spring loaded scissor mechanism allows shelter to retract with the trailer keeping the shelter square. The design also eliminates the need for rigid steel guide protectors. The reinforced 40 oz. vinyl flaps close the opening down to 90"W x 90"H. The 36" header curtain has armor pleats for extended wear. Shelter is black with aluminum edge trim. Draft pads included standard. To ensure proper size complete and fax the survey sheet shown on page A39. Units are non-returnable.

MODEL NUMBER	PROJECTION	OVERALL HEIGHT	OVERALL WIDTH	NET WT. (POUNDS)
D-520-24	24"	132"	132"	590



Dock Seal Draft Blocker

Designed for blocking drafts between dock seals and dock levelers. Compressible foam provides sealing action in all types of irregular gaps. Top carrying handles for easy removal. Air vent allows bag to return to original shape. Grommets for tether attachment (not included). Filled with foam for compressibility. Black vinyl construction with yellow stripes.



MODEL NUMBER	OVERALL WIDTH	OVERALL LENGTH	OVERALL HEIGHT	NET WT. (POUNDS)
DRAFT-18	18"	12"	9"	6
DRAFT-24	24"	12"	9"	9
DRAFT-36	36"	12"	9"	12



DOCK SEAL AND SHELTER OPTIONS

MODEL NUMBER	DESCRIPTION
D-FHPFS	Full height pleats & full height guide stripes for Seals and Shelters
D-FHPS	Full Height Pleats, Standard Guide Stripes (24" High)
D-AP	Armor Pleats, Top 24" Only
D-54OZ	54 Ounce Material - Face Only
D-18H	18" Header
D-SV	Sloped Verticals
D-BBF	Bottom Bun
D-BBFB	Bottom Bun with Bumpers
D-GS	Full Height Guide Stripes
D-12F	12" Flap
D-SIDE	Dock Seal Sides Between 97" & 120"
D-KIT	Optional six piece vinyl patch material, including glue and instructions

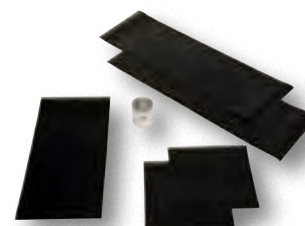

REPAIR KIT • model D-KIT





CURTAIN SLIDES SMOOTHLY FROM SIDE TO SIDE



CURTAIN ROLLS UP AND DOWN



Dock Bug Screen Doors 115V 1-PHASE STANDARD

Improve employee comfort while increasing productivity. It is used at loading docks, garages, and food processing facilities. Keeps birds, flies, moths, mosquitoes, wasps, and other insects out while providing fresh air ventilation, sunlight, and increased security. It is constructed of durable, all weather vinyl coated polyester that is fire retardant as well as mildew and UV resistant. Easy to install. Operation involves a simple manual roller and track system that allows the screen to slide smoothly from side to side, or easy roll up and down system that is available spring loaded or motorized.

Colors Available

Add color to suffix of model number. Color shown may differ from actual color.

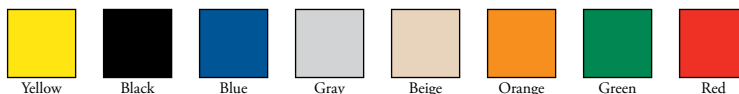

MANUAL ROLLER AND TRACK SYSTEM

MODEL NUMBER	OPERATION	DOOR SIZE (W x H)	MOUNT	NET WT. (POUNDS)
DBS-88-H	SLIDING	8' x 8'	IN JAMB	100
DBS-810-H	SLIDING	8' x 10'	IN JAMB	115
DBS-1010-H	SLIDING	10' x 10'	IN JAMB	125
DBS-88-W	SLIDING	8' x 8'	MOUNTS ON INSIDE WALL	115
DBS-810-W	SLIDING	8' x 10'	MOUNTS ON INSIDE WALL	130
DBS-1010-W	SLIDING	10' x 10'	MOUNTS ON INSIDE WALL	140

ROLL UP AND DOWN SYSTEM

MODEL NUMBER	OPERATION	DOOR SIZE (W x H)	MOUNT	NET WT. (POUNDS)
DBS-88-SL-H	SPRING LOAD ROLL UP	8' x 8'	IN JAMB	100
DBS-810-SL-H	SPRING LOAD ROLL UP	8' x 10'	IN JAMB	115
DBS-1010-SL-H	SPRING LOAD ROLL UP	10' x 10'	IN JAMB	125
DBS-88-ITM-H	IN-TUBE MOTORIZED	8' x 8'	IN JAMB	110
DBS-810-ITM-H	IN-TUBE MOTORIZED	8' x 10'	IN JAMB	125
DBS-1010-ITM-H	IN-TUBE MOTORIZED	10' x 10'	IN JAMB	135

Dock Bug Wire Mesh Door 115V 1-PHASE STANDARD

Stop trespassing, and at the same time, let in natural sunlight and fresh air with the Wire Mesh Dock Door. Doors are made with a 15 gauge aluminum with a 1/2" coil wire mesh, and heavy duty extruded aluminum "C" channel guide track which is 1.25" wide x 4" deep. Safety yellow and black strips are standard on the interior edge of the panel. Horizontal stiffeners are constructed with 3/4" fiberglass wind load rods and are inserted into specially constructed coils for horizontal stability, visibility, and increased safety.

MODEL NUMBER	OPERATION	DOOR SIZE (W x H)	MOUNT	NET WT. (POUNDS)
DWM-88-ITM-W	IN-TUBE MOTORIZED	8' x 8'	WALL	150
DWM-810-ITM-W	IN-TUBE MOTORIZED	8' x 10'	WALL	165
DWM-1010-ITM-W	IN-TUBE MOTORIZED	10' x 10'	WALL	175

Construction Chutes

Polyethylene trash chutes are the choice of suppliers & contractors throughout North America. Superb ease-of-use and durability provide a quick, clean, & safe solution. Our designs have been perfected to provide you with the right tool for debris removal. Ideal for; Builders, Roofers, Scaffolders, Masons, Demo Contractors, Supply Houses, Rental Stores, and Renovators. These tapered tubes attach quickly & easily to one another using built-in cable assemblies. Entry doors allow debris to be cleared from any floor level. CC-30-MC is used for heavier debris, such as concrete, and CC-30-TC is used for lighter debris, such as shingles. Use Basic Support Frame and Parapet Outrigger when supporting from top of roof.



MODEL NUMBER	DESCRIPTION	OVERALL SIZE (D x L x H)	NET WT. (LBS.)
CC-30-TH	TOP HOPPER	30" x 48" x 28"	150
CC-30-MC	MEDIUM GAUGE CHUTE	32" x 48" x 48"	96
CC-30-TC	THIN GAUGE CHUTE	48" x 96" x 42"	90
CC-30-ED	ENTRY DOOR	29" x 48" x 28"	190
CC-30-SF	BASIC SUPPORT FRAME		69
CC-30-PO	PARAPET OUTRIGGER (to mount to above support)		91

Vinyl Strip Doors

Vinyl Strip Doors help control noise, dust, fumes, and smoke while minimizing drafts, reducing illnesses, and accidents. The strip doors offer visual clarity without sacrificing safety and the fire resistant material is self-extinguishing. The simple low cost design is easy to maintain, while reducing heating and cooling costs.

MODEL FORMAT

TG - **SERIES** - **OVERLAP** - **MOUNTING** - **WIDTH (")** - **HEIGHT (")**

SERIES "600" SERIES STRIPS ARE 6" WIDE x 0.06" THICK
 "800" SERIES STRIPS ARE 8" WIDE x 0.08" THICK
 "1200" SERIES STRIPS ARE 12" WIDE x 0.12" THICK
 "1600" SERIES STRIPS ARE 16" WIDE x 0.16" THICK

OVERLAP "S" FOR STANDARD 2/3 OVERLAP
 "F" FOR FULL OVERLAP

MOUNTING "H" FOR HEADER MOUNT (STANDARD)
 "W" FOR WALL MOUNT (EXTRA COST)



PRICE FORMULA (IN FEET)

	MOUNTING		STRIPS
TG-600-S	(XXX x WIDTH')	+	(XXX x WIDTH' x HEIGHT')
TG-600-F	(XXX x WIDTH')	+	(XXX x WIDTH' x HEIGHT')
TG-800-S	(XXX x WIDTH')	+	(XXX x WIDTH' x HEIGHT')
TG-800-F	(XXX x WIDTH')	+	(XXX x WIDTH' x HEIGHT')
TG-1200-S	(XXX x WIDTH')	+	(XXX x WIDTH' x HEIGHT')
TG-1200-F	(XXX x WIDTH')	+	(XXX x WIDTH' x HEIGHT')
TG-1600-S	(XXX x WIDTH')	+	(XXX x WIDTH' x HEIGHT')
TG-1600-F	(XXX x WIDTH')	+	(XXX x WIDTH' x HEIGHT')

NOTE: WIDTH AND HEIGHT IS SIZE OF DOOR OPENING IN FEET

STRIP DOOR OPTIONS

- H - HEADER MOUNT
- W - WALL MOUNT
- RIBBED MATERIAL (8" & 12")
- LOW TEMPERATURE MATERIAL (-50°F) (8" & 12")
- BRONZE WELD SCREEN MATERIAL (8" & 12")
- ORANGE OPAQUE MATERIAL (6", 8", 12" & 16")

STRIP DOOR NET WEIGHT FORMULA (IN FEET)

	MOUNTING		STRIPS
TG-600-S	(2 x WIDTH')	+	(1.00 x WIDTH' x HEIGHT')
TG-600-F	(2 x WIDTH')	+	(1.25 x WIDTH' x HEIGHT')
TG-800-S	(2 x WIDTH')	+	(1.00 x WIDTH' x HEIGHT')
TG-800-F	(2 x WIDTH')	+	(1.25 x WIDTH' x HEIGHT')
TG-1200-S	(2 x WIDTH')	+	(1.00 x WIDTH' x HEIGHT')
TG-1200-F	(2 x WIDTH')	+	(1.25 x WIDTH' x HEIGHT')
TG-1600-S	(2 x WIDTH')	+	(1.00 x WIDTH' x HEIGHT')
TG-1600-F	(2 x WIDTH')	+	(1.25 x WIDTH' x HEIGHT')

NOTE: WIDTH AND HEIGHT IS SIZE OF DOOR OPENING IN FEET

REPLACEMENT STRIPS

TG - STRIP - **WIDTH (6, 8, 12, 16 INCHES)** - **LENGTH IN FEET**

6 INCH x .06 INCH	(300 FEET/ROLL)	57#/ROLL
8 INCH x .08 INCH	(300 FEET/ROLL)	90#/ROLL
12 INCH x .12 INCH	(200 FEET/ROLL)	144#/ROLL
16 INCH x .16 INCH	(100 FEET/ROLL)	144#/ROLL
8 INCH RIBBED	(150 FEET/ROLL)	55#/ROLL
12 INCH RIBBED	(150 FEET/ROLL)	120#/ROLL

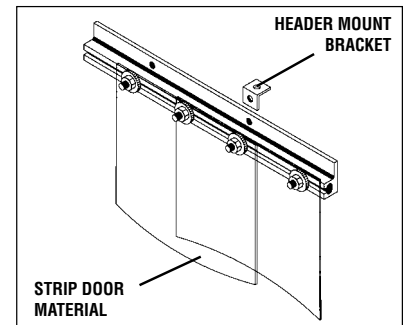

PRE-ASSEMBLED STRIP DOORS
 ALL DOORS ARE SHIPPED
 PRE-ASSEMBLED AND READY
 FOR INSTALLATION. INSTALLATION
 HARDWARE NOT INCLUDED.



STANDARD 2/3 OVERLAP



FULL OVERLAP

**STANDARD MATERIAL
 MEETS USDA
 REQUIREMENTS**

**NOTE: STRIP DOORS
 ARE CUT TO SIZE,
 THEREFORE THEY ARE
 NON-RETURNABLE**



model YR-16-7236

Steel Yard Ramps

Quickly load and unload trucks, trailers, and rail cars from ground level when no freight dock exists. Increase productivity while reducing material handling costs. Great for construction sites. A manual two-speed hand crank for easy one person height adjustment offers a service range of 45" to 62". Available in 30 foot of straight ramp or 36 foot overall length; 30 foot of straight ramp and 6 foot level off. Standard features include: 9" steel wheels, positive traction open steel grating, safety locking chains, 4" high steel safety curbs, rubber bumpers, 15" overlap lip, fork positioning loop, and welded steel construction. Painted neutral earth-tone brown. All units must ship flatbed truck.



MANUAL HAND CRANK & 9" STEEL WHEELS



SAFETY LOCKING CHAINS WITH 15" OVERLAP LIP

OPTIONS



27" PNEUMATIC TIRES



HYDRAULIC HAND PUMP model YR-HL



TOW BAR HITCH model YR-TB-H



TOW BAR POCKET model YR-TB-P



FORK LIFT PICK-UP SLOTS model YR-FS



NON-REMOVABLE STEEL HANDRAIL model YR-HDRL



GALVANIZED GUARD RAIL series YR-GR

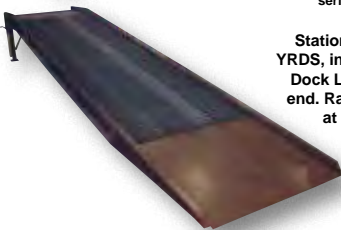

Stationary ramps, series YRDS, include an Edge-Of-Dock Leveler at the truck end. Ramp height is fixed at 50". Leveler offers service range of +/- 5".

PORTABLE STEEL YARD RAMPS

MODEL NUMBER	UNIFORM CAPACITY (LBS.)	OVERALL** RAMP WIDTH	USABLE RAMP WIDTH	LENGTH (FEET)	NET WT. (LBS.)
YR-16-7230	16,000	72"	66"	30	3780
YR-16-8430	16,000	84"	78"	30	4095
YR-16-7236	16,000	72"	66"	36	4725
YR-16-8436	16,000	84"	78"	36	5040
YR-20-7330	20,000	73"	66"	30	4515
YR-20-8530	20,000	85"	78"	30	4830
YR-20-7336	20,000	73"	66"	36	5565
YR-20-8536	20,000	85"	78"	36	5985
YR-25-7330	25,000	73"	66"	30	4725
YR-25-8530	25,000	85"	78"	30	5040
YR-25-7336	25,000	73"	66"	36	5880
YR-25-8536	25,000	85"	78"	36	6300
YR-30-7330	30,000	73"	66"	30	4935
YR-30-8530	30,000	85"	78"	30	5250
YR-30-7336	30,000	73"	66"	36	6300
YR-30-8536	30,000	85"	78"	36	6720

**ADD 19" TO OVERALL RAMP WIDTH FOR MAXIMUM OVERALL WIDTH. THIS INCLUDES LANDING GEAR AND CRANK MECHANISM.

PORTABLE STEEL YARD RAMPS WITH HAND PUMP HYDRAULIC EDGE-O-DOCK

MODEL NUMBER	UNIFORM CAPACITY (LBS.)	OVERALL WIDTH	USABLE WIDTH	LENGTH (FEET)	NET WT. (LBS.)
YRD-16-7236-H	16,000	72"	66"	36	5670
YRD-16-8436-H	16,000	84"	78"	36	6090
YRD-20-7336-H	20,000	73"	66"	36	5880
YRD-20-8536-H	20,000	85"	78"	36	6300
YRD-25-7336-H	25,000	73"	66"	36	6090
YRD-25-8536-H	25,000	85"	78"	36	6510
YRD-30-7336-H	30,000	73"	66"	36	6300
YRD-30-8536-H	30,000	85"	78"	36	6720

LEVELER IS 64" WIDE ON 72" & 73" MODELS AND 75" WIDE ON 84" & 85" MODELS

STATIONARY STEEL YARD RAMPS WITH EDGE-O-DOCK

MODEL NUMBER	UNIFORM CAPACITY (LBS.)	OVERALL WIDTH	USABLE WIDTH	LENGTH (FEET)	NET WT. (LBS.)
MECHANICAL EDGE-O-DOCK AT TRUCK END					
YRDS-16-7236-M	16,000	72"	66"	36	5905
YRDS-16-8536-M	16,000	85"	78"	36	6325
YRDS-20-8536-M	20,000	85"	78"	36	6535
HAND PUMP HYDRAULIC EDGE-O-DOCK AT TRUCK END					
YRDS-16-7236-H	16,000	72"	66"	36	5890
YRDS-16-8536-H	16,000	85"	78"	36	6310
YRDS-20-8536-H	20,000	85"	78"	36	6520

LEVELER IS 66" WIDE ON 72" & 73" MODELS AND 72" WIDE ON 84" & 85" MODELS

STEEL YARD RAMP OPTIONS

MODEL NUMBER	DESCRIPTION	NET WT. (LBS.)
YR-HL	PNEUMATIC TIRE & HAND PUMP HYDRAULIC LIFT (5 MPH MAX. TOW SPEED) (NOT AVAILABLE ON YRD MODELS)	230
YR-HL-DC*	PNEUMATIC TIRE & 12V DC HYDRAULIC LIFT (5 MPH MAX. TOW SPEED) (NOT AVAILABLE ON YRD MODELS)	288
YR-FS	FORK LIFT PICKUP SLOTS (7½"W X 2½"H USABLE ON 24" CENTERS)	460
YR-TB-H	TOW BAR HITCH	145
YR-TB-P	TOW BAR POCKET	35
YR-GR-30	12" HIGH GUARD RAIL OPTION FOR 30 FEET RAMPS (BOTH SIDES)	456
YR-GR-36	12" HIGH GUARD RAIL OPTION FOR 36 FEET RAMPS (BOTH SIDES)	550
YR-HDRL	NON-REMOVABLE 42" HIGH STEEL HANDRAIL WITH 21" MIDRAIL (WELDED)	9/FT.
YR-RHDRL	REMOVABLE 42" HIGH STEEL HANDRAIL WITH 21" MIDRAIL	9/FT.
YR-RAHDRL	REMOVABLE 42" HIGH ALUMINUM HANDRAIL WITH 21" MIDRAIL	3/FT.
YRD-MD	MECHANICAL DOCKLEVELER IN LIEU OF HYDRAULIC (ON 16,000, 20,000, AND 25,000 LBS. CAPACITIES)	--
YR-DH	HOLES IN LIP TO LAG RAMP TO TOP OF DOCK	--

*INCLUDES ON-BOARD CHARGER

Aluminum Yard Ramps

Portable Aluminum Yard Ramps have a unique design that allows one person to position the ramp, adjust its service height, and load or unload trailers from ground level. Available with steel or rust resistant aluminum grating. Standard features: Hand pump hydraulic lift, safety pressure relief valve, 18" x 5" mold-on-rubber tires, 4" high curbs, service range of 45" to 62", anchor chains, and fork positioning loop. Yard Ramps ship flatbed truck.

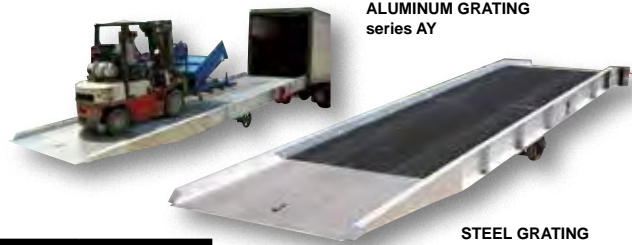

ALUMINUM YARD RAMPS WITH STEEL GRATING					
MODEL NUMBER	UNIFORM CAPACITY (LBS.)	OVERALL WIDTH	USABLE WIDTH	LENGTH (FEET)	NET WT. (POUNDS)
SY-167230	16,000	74"	66"	30	3518
SY-168430	16,000	86"	78"	30	4043
SY-169330	16,000	95"	87"	30	4515
SY-167236-L	16,000	74"	66"	36	4305
SY-168436-L	16,000	86"	78"	36	4830
SY-169336-L	16,000	95"	87"	36	5303
SY-207230	20,000	74"	66"	30	3623
SY-208430	20,000	86"	78"	30	4148
SY-209330	20,000	95"	87"	30	4620
SY-207236-L	20,000	74"	66"	36	4410
SY-208436-L	20,000	86"	78"	36	4935
SY-209336-L	20,000	95"	87"	36	5408
SY-257230	25,000	74"	66"	30	3675
SY-258430	25,000	86"	78"	30	4200
SY-259330	25,000	95"	87"	30	4725
SY-257236-L	25,000	74"	66"	36	4463
SY-258436-L	25,000	86"	78"	36	4988
SY-259336-L	25,000	95"	87"	36	5513
SY-307230	30,000	74"	66"	30	3728
SY-308430	30,000	86"	78"	30	4253
SY-307236-L	30,000	74"	66"	36	4515
SY-308436-L	30,000	86"	78"	36	5040
ALUMINUM YARD RAMPS WITH ALUMINUM GRATING					
MODEL NUMBER	UNIFORM CAPACITY (LBS.)	OVERALL WIDTH	USABLE WIDTH	LENGTH (FEET)	NET WT. (POUNDS)
AY-167230	16,000	74"	66"	30	2783
AY-168430	16,000	86"	78"	30	3150
AY-169330	16,000	95"	87"	30	3465
AY-167236-L	16,000	74"	66"	36	3360
AY-168436-L	16,000	86"	78"	36	3728
AY-169336-L	16,000	95"	87"	36	3990
AY-207230	20,000	74"	66"	30	2888
AY-208430	20,000	86"	78"	30	3255
AY-209330	20,000	95"	87"	30	3570
AY-207236-L	20,000	74"	66"	36	3465
AY-208436-L	20,000	86"	78"	36	3833
AY-209336-L	20,000	95"	87"	36	4095
AY-257230	25,000	74"	66"	30	2940
AY-258430	25,000	86"	78"	30	3308
AY-259330	25,000	95"	87"	30	3675
AY-257236-L	25,000	74"	66"	36	3578
AY-258436-L	25,000	86"	78"	36	3885
AY-259336-L	25,000	95"	87"	36	4200
AY-307230	30,000	74"	66"	30	3092
AY-308430	30,000	86"	78"	30	3360
AY-307236-L	30,000	74"	66"	36	3570
AY-308436-L	30,000	86"	78"	36	3938



18" x 5" MOLD-ON-RUBBER TIRES ARE STANDARD



HAND PUMP HYDRAULIC LIFT STANDARD



15" OVERLAP INTO TRAILER/BUILDING SAFETY CHAINS STANDARD



PNEUMATIC TIRES OPTION Service Range will be 40" to 66" model AY-PNTR

ALUMINUM YARD RAMP OPTIONS		
MODEL NUMBER	DESCRIPTION	NET WT. (POUNDS)
AYR-HL-DC	12V DC HYDRAULIC LIFT (INCLUDES ON-BOARD CHARGER)	50
AYR-TB-H	TOW BAR HITCH	145
YR-TB-P	TOW BAR POCKET	35
AYR-GR-30	12" HIGH GUARD RAIL OPTION FOR 30 FEET RAMPS	456
AYR-GR-36	12" HIGH GUARD RAIL OPTION FOR 36 FEET RAMPS	550
AY-AHDRL	NON-REMOVABLE 42" HIGH ALUMINUM HANDRAIL WITH 21" MIDRAIL (WELDED)	3/FT.
AY-RAHDRL	REMOVABLE 42" HIGH ALUMINUM HANDRAIL WITH 21" MIDRAIL	3/FT.
AY-RHDRL	REMOVABLE 42" HIGH STEEL HANDRAIL WITH 21" MIDRAIL	9/FT.
AYR-CRB6	6" CURB HEIGHT	--
AYR-YEL	YELLOW SAFETY CURBS	--
AY-PNTR	20½" x 8" PNEUMATIC TIRE OPTION (SERVICE RANGE 40" TO 66")	--
AYR-DH	HOLES IN LIP TO LAG RAMP TO TOP OF DOCK	--





Steel Railroad Dockboards

Model Number Format:

RS - CAPACITY - WIDTH - "A" DIMENSION - "B" DIMENSION

The Steel Railroad Dockboard has a rectangular-style with a deck that is made of high-strength raised diamond steel treadplate with structural steel support beams for high strength cross traffic. Treadplate provides increased traction; overlap-style lip on both dock and rail car ends gives maximum versatility. Fork truck pop-up loops are built into deck - automatically pop-up when board is set on floor. Automatic drop-locks on both sides of board are designed to keep the board in place between dock and rail car. Auto drop locks add thirteen (13) inches to overall width. All purchase orders must include A, B and C dimensions (see below survey sheet). Non-returnable.

STANDARD FEATURES

- Auto Drop Locks (add 13" to overall width)**
- Pop-up Fork Lift Loops
- Steel Rectangular Board
- Overlap Style Plate (both ends)
- Safety Curbs are 4" High
- High Strength Cross Traffic
- Tread plate for Better Traction
- Structural Steel Support Beams



DROP LOCKS are designed to automatically keep the railboard tight against the car, accommodating for various railcar widths. These cast bars measure 1" thick. (standard)



POP-UP-LOOPS

ALTERNATIVE DESIGN OPTIONS

- Replace pick-up loops with chains
- Replace automatic-drop locks with pin locks
- Flush Style Plate, replaces overlap style and minimizes board overlap into car
- Flared Board offers greater flexibility for tight turning radius applications. Contact factory for pricing.
- Specials: Different widths and configurations are available, contact factory for pricing.



PIN LOCKS provide an economical alternative to the drop locks. (alternative design)



PICK UP CHAINS provide an economical alternative to pick up loops. (alternative)

SURVEY SHEET

REQUIRED FOR ALL RAILBOARD QUOTES

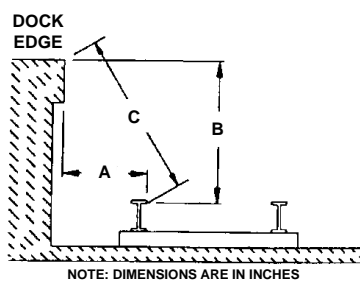

A _____

B _____

C _____

DIMENSION "A"	BOARD LENGTH	15,000 LBS.	20,000 LBS.	30,000 LBS.	40,000 LBS.
		UNIFORM CAPACITY	UNIFORM CAPACITY	UNIFORM CAPACITY	UNIFORM CAPACITY
66 INCH USABLE / 72 INCH WIDE BOARD**					
		Weight	Weight	Weight	Weight
49-51"	33-35"	716	791	828	891
52-54"	36-38"	735	811	860	926
55-57"	39-41"	759	800	916	990
58-60"	42-44"	801	849	950	1025
61-63"	45-47"	817	903	1009	1087
64-66"	48-50"	834	923	1041	1122
67-69"	51-53"	880	947	1084	1180
70-72"	54-56"	898	1010	1114	1214
73-75"	57-59"	949	1069	1171	1278
76-78"	60-62"	972	1096	1199	1307
79-81"	63-65"	1013	1142	1262	1376
82-84"	66-68"	1030	1161	1293	1411
85-87"	69-71"	1076	1214	1331	1468
88-90"	72-74"	1099	1251	1362	1503
91-93"	75-77"	1146	1305	1414	1561
94-96"	78-80"	1175	1338	1477	1630
78 INCH USABLE / 84 INCH WIDE BOARD**					
49-51"	33-35"	765	812	891	960
52-54"	36-38"	813	869	924	995
55-57"	39-41"	830	904	987	1064
58-60"	42-44"	857	956	1019	1099
61-63"	45-47"	880	982	1094	1180
64-66"	48-50"	926	1034	1125	1214
67-69"	51-53"	956	1066	1178	1284
70-72"	54-56"	1007	1143	1247	1318
73-75"	57-59"	1036	1168	1283	1399
76-78"	60-62"	7076	1213	1314	1434
79-81"	63-65"	1111	1253	1377	1503
82-84"	66-68"	1157	1306	1403	1538
85-87"	69-71"	1180	1332	1456	1607
88-90"	72-74"	1226	1396	1498	1653
91-93"	75-77"	1256	1430	1560	1723
94-96"	78-80"	1284	1468	1619	1803
102 INCH USABLE / 108 INCH WIDE BOARD**					
49-51"	33-35"	855	917	1109	1191
52-54"	36-38"	909	1031	1146	1237
55-57"	39-41"	983	1118	1236	1336
58-60"	42-44"	1006	1144	1274	1376
61-63"	45-47"	1071	1216	1365	1475
64-66"	48-50"	1110	1263	1413	1526
67-69"	51-53"	1168	1330	1482	1617
70-72"	54-56"	1203	1380	1542	1665
73-75"	57-59"	1261	1447	1645	1688
76-78"	60-62"	1295	1488	1650	1803
79-81"	63-65"	1371	1575	1745	1907
82-84"	66-68"	1399	1608	1788	1954
85-87"	69-71"	1457	1875	1851	2046
88-90"	72-74"	1503	1744	1903	2104
91-93"	75-77"	1549	1798	1986	2196
94-96"	78-80"	1590	1845	2027	2265

Aluminum Hand Truck Dockplates

This Aluminum Hand Truck Dockplate is designed for use with two (2) wheel hand trucks. It is a convenient, safe, and an easy way to access loading docks from trucks. This dockplate is lightweight and easily transported by just one person. The tread plate surface ensures skid-resistant safe traction and the locking legs secure the plate for safe loading and unloading. Complete with bolt-on zinc plated carrying handles and locking legs.

48 Hours
to Ship

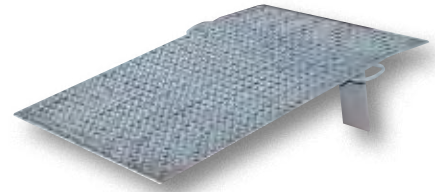

DESIGNED FOR USE WITH TWO WHEEL HAND TRUCKS (not included)

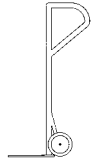

PLATE* WIDTH	PLATE LENGTH	HEIGHT DIFF.	1/4" PLATE THICKNESS			5/16" PLATE THICKNESS		
			MODEL NUMBER	NET WT. (LBS.)	UNIFORM CAPACITY	MODEL NUMBER	NET WT. (LBS.)	UNIFORM CAPACITY
30"	24"	3"	A-3024	28	500	AH-3024	31	700
30"	30"	4"	A-3030	33	500	AH-3030	35	700
30"	36"	5"	A-3036	40	500	AH-3036	45	700
30"	48"	7"	A-3048	44	500	AH-3048	53	700
36"	24"	3"	A-3624	32	500	AH-3624	37	700
36"	30"	4"	A-3630	37	500	AH-3630	43	700
36"	36"	5"	A-3636	46	500	AH-3636	54	700
36"	48"	7"	A-3648	55	500	AH-3648	63	700

*ADD 4 1/2" TO GET OVERALL WIDTH

Aluminum Economizer Dockplates

The Aluminum Economizer Dockplate is an economical way to speed up truck loading and unloading. Spans the opening between dock and trailer to allow pallet or hand trucks along with traffic to safely move in and out of the trailer. The dockplate is constructed of high strength, non-skid aluminum alloy tread plate. The lightweight design with bolt-on zinc plated legs and handles on each side makes portability easy. Locking legs for OSHA compliance. The bend or crown is 11° and located 9" from edge of dockplate. Not for use with fork trucks.

48 Hours
to Ship

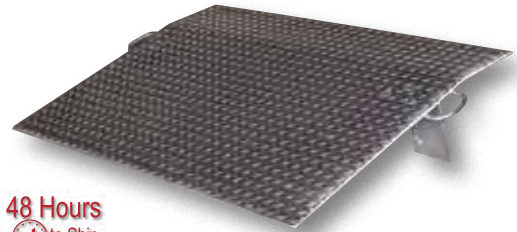

PLATE* WIDTH	PLATE LENGTH	HEIGHT DIFF.	3/8" PLATE THICKNESS				1/2" PLATE THICKNESS			
			MODEL NUMBER	SHIPS VIA	NET WT. (LBS.)	UNIFORM CAPACITY	MODEL NUMBER	SHIPS VIA	NET WT. (LBS.)	UNIFORM CAPACITY
30"	24"	3"	E-3024	UPS	35	3,000	EH-3024	UPS	42	5,200
30"	30"	4"	E-3030	UPS	40	2,300	EH-3030	UPS	50	4,100
30"	36"	5"	E-3036	UPS	49	1,800	EH-3036	UPS	61	3,500
30"	48"	7"	E-3048	UPS	59	1,400	EH-3048	UPS	74	2,600
36"	24"	3"	E-3624	UPS	45	3,600	EH-3624	UPS	49	6,200
36"	30"	4"	E-3630	UPS	55	3,000	EH-3630	UPS	60	5,100
36"	36"	5"	E-3636	UPS	71	2,500	EH-3636	UPS	71	4,300
36"	48"	7"	E-3648	UPS	88	1,900	EH-3648	UPS	89	3,000
42"	24"	3"	E-4224	UPS	44	4,300	EH-4224	UPS	56	7,200
42"	30"	4"	E-4230	UPS	51	3,300	EH-4230	UPS	67	5,900
42"	48"	7"	E-4248	LTL	80	2,100	EH-4248	LTL	103	3,500
48"	24"	3"	E-4824	UPS	48	5,200	EH-4824	UPS	55	8,200
48"	30"	4"	E-4830	UPS	63	4,100	EH-4830	UPS	73	6,300
48"	36"	5"	E-4836	UPS	71	3,500	EH-4836	UPS	89	5,300
48"	42"	6"	E-4842	LTL	81	3,000	EH-4842	LTL	103	4,300
48"	48"	7"	E-4848	LTL	91	2,600	EH-4848	LTL	118	3,800
48"	54"	8"	E-4854	LTL	102	2,200	EH-4854	LTL	133	3,300
48"	60"	9"	E-4860	LTL	112	1,800	EH-4860	LTL	153	2,900
60"	24"	3"	E-6024	UPS	60	5,700	EH-6024	UPS	75	10,000
60"	30"	4"	E-6030	UPS	69	4,600	EH-6030	UPS	88	7,800
60"	36"	5"	E-6036	LTL	75	4,100	EH-6036	LTL	109	6,600
60"	42"	6"	E-6042	LTL	107	3,500	EH-6042	LTL	127	5,500
60"	48"	7"	E-6048	LTL	119	2,900	EH-6048	LTL	145	4,800
60"	54"	8"	E-6054	LTL	127	2,400	EH-6054	LTL	159	4,100
60"	60"	9"	E-6060	LTL	136	2,000	EH-6060	LTL	177	3,700
72"	24"	3"	E-7224	UPS	84	6,500	EH-7224	UPS	87	11,900
72"	30"	4"	E-7230	LTL	92	5,400	EH-7230	LTL	106	9,500
72"	36"	5"	E-7236	LTL	100	4,300	EH-7236	LTL	129	7,800
72"	48"	7"	E-7248	LTL	138	3,400	EH-7248	LTL	173	5,900

*OVERALL WIDTH IS PLATE WIDTH PLUS 9"

ALUMINUM ECONOMIZER DOCKPLATE OPTIONS			
MODEL NUMBER	DESCRIPTION	MODEL NUMBER	DESCRIPTION
OHDL	No Handles	SLL	Special Location of Legs
1HDL	One Handle	ATC	Anti-Theft Chain (PER LINEAR FOOT)
SDP	Smooth Deck Plate (Diamond Side Down)	LHDL	Extra Pair of Legs with Handles & Hardware
SB	Special Bend or Location of Bend	TRADE	Trade in Allowance (F.O.B. IN)

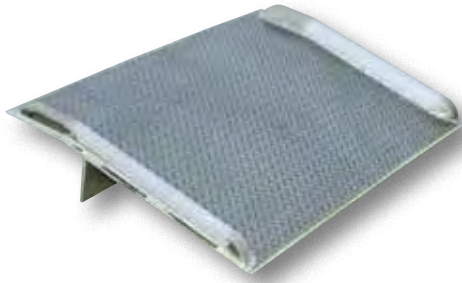

Aluminum Truck Dockboards (Welded Aluminum Curbs)

The Aluminum Truck Dockboard is engineered and built to maximize safety while handling heavy fork trucks and loads. The beveled edge is designed for smooth entry and exit. Locking legs prevent movement during loading and unloading operations. Locking legs are uneven to allow the dockboard to sit canted, while not in use, for easier pickup by fork trucks. Welded aluminum safety curbs prevent accidental runoffs and provide a visible driving lane. When using three-wheeled fork trucks order dockboard with capacity at least four-times the lifting capacity of fork truck. The width of the dockboard should be at least 15 (in.) wider than the load or equipment passing between the curbs. Bend is 11° and 9° from the edge and the legs are 12" from the edge. Manufactured in compliance with OSHA.

CAPACITY is based upon the heaviest type of equipment used plus the maximum load carried times the single axle rating of total load. Dynamic loading, driver tendencies, speed, and frequency of use must be considered. Steel (TS-series) dockboards recommended for high use docks.

Use this guide for truck floor heights to determine the Height Differential from the truck bed to dock. (Numbers listed reference an empty truck.)

EQUIPMENT	SINGLE AXLE RATING OF TOTAL LOAD
TWO-WHEEL HAND TRUCKS	100%
FOUR-WHEEL PLATFORM TRUCK - (NON-TILT)	50%
PALLET TRUCKS - HAND	75%
PALLET TRUCKS - ELECTRIC	66%
PLATFORM (SKID) TRUCKS - HAND - WALKIE	75%
PLATFORM (SKID) TRUCKS - ELECTRIC - WALKIE	66%
FORK TRUCKS - ELECTRIC WALKIE	90%
FORK TRUCKS - ELECTRIC RIDER	90%
FORK TRUCKS - GAS RIDER	90%

REFRIGERATED	54" to 61"
HEAVY TRAILERS	51" to 56"
HEAVY SEMI-TRAILERS	48" to 54"
LIGHT SEMI-TRAILERS	45" to 49"
LARGE SINGLE BED	42" to 50"
SMALL SINGLE BED	30"

Use first & second column of chart below to determine length of board.
 Rise/Run (x 100) = % of Grade.

UNIFORM CAPACITY				5,000 LBS.		6,000 LBS.		8,000 LBS.		10,000 LBS.	
Size Width-Length Inches	Ht. Difference 8 1/17% Inches	Ht. Difference 11 1/19% Inches	Model Number		Model Number		Model Number		Model Number		
				Net Wt. (lbs.)		Net Wt. (lbs.)		Net Wt. (lbs.)		Net Wt. (lbs.)	
54	36	4	BTA-05005436	79	BTA-06005436	73	BTA-08005436	112			
	48	5 1/2	BTA-05005448	98	BTA-06005448	109	BTA-08005448	118			
	60	7	BTA-05005460	124	BTA-06005460	134	BTA-08005460	149			
60	30	3	BTA-05006030	72	BTA-06006030	81	BTA-08006030	100	BTA-10006030	106	
	36	4	BTA-05006036	82	BTA-06006036	91	BTA-08006036	110	BTA-10006036	123	
	42	5	BTA-05006042	95	BTA-06006042	101	BTA-08006042	114	BTA-10006042	136	
	48	5 1/2	BTA-05006048	105	BTA-06006048	120	BTA-08006048	126	BTA-10006048	173	
	54	6	BTA-05006054	123	BTA-06006054	132	BTA-08006054	151	BTA-10006054	194	
	60	7	BTA-05006060	133	BTA-06006060	144	BTA-08006060	166	BTA-10006060	197	
	66	8	BTA-05006066	156	BTA-06006066	156	BTA-08006066	172	BTA-10006066	215	
	72	8 1/2	BTA-05006072	163	BTA-06006072	164	BTA-08006072	191	BTA-10006072	251	
	78	9	BTA-05006078	175	BTA-06006078	179	BTA-08006078	202	BTA-10006078	264	
84	10	BTA-05006084	197	BTA-06006084	185	BTA-08006084	205	BTA-10006084	285		
66	36	4	BTA-05006636	96	BTA-06006636	150	BTA-08006636	112	BTA-10006636	136	
	48	5 1/2	BTA-05006648	116	BTA-06006648	208	BTA-08006648	125	BTA-10006648	208	
	60	7	BTA-05006660	126	BTA-06006660	241	BTA-08006660	214	BTA-10006660	220	
72	30	3	BTA-05007230	85	BTA-06007230	81	BTA-08007230	120	BTA-10007230	126	
	36	4	BTA-05007236	92	BTA-06007236	91	BTA-08007236	145	BTA-10007236	161	
	48	5 1/2	BTA-05007248	152	BTA-06007248	130	BTA-08007248	204	BTA-10007248	189	
	60	7	BTA-05007260	195	BTA-06007260	200	BTA-08007260	212	BTA-10007260	247	
78	36	4	BTA-05007836	164	BTA-06007836	158	BTA-08007836	188	BTA-10007836	168	
	48	5 1/2	BTA-05007848	196	BTA-06007848	171	BTA-08007848	196	BTA-10007848	215	
	60	7	BTA-05007860	228	BTA-06007860	186	BTA-08007860	206	BTA-10007860	276	
84	36	4	BTA-05008436	98	BTA-06008436	209	BTA-08008436	126	BTA-10008436	195	
	48	5 1/2	BTA-05008448	160	BTA-06008448	218	BTA-08008448	156	BTA-10008448	232	
	60	7	BTA-05008460	212	BTA-06008460	235	BTA-08008460	188	BTA-10008460	250	

UNIFORM CAPACITY				12,000 LBS.		15,000 LBS.		20,000 LBS.	
Size Width-Length Inches	Ht. Difference 11 1/19% Inches	Ht. Difference 11 1/19% Inches	Model Number		Model Number		Model Number		
				Net Wt. (lbs.)		Net Wt. (lbs.)		Net Wt. (lbs.)	
60	30	3	BTA-12006030	106	BTA-15006030	132	BTA-20006030	154	
	36	4	BTA-12006036	136	BTA-15006036	141	BTA-20006036	177	
	48	5 1/2	BTA-12006048	196	BTA-15006048	180	BTA-20006048	206	
	54	6	BTA-12006054	210	BTA-15006054	206	BTA-20006054	250	
	60	7	BTA-12006060	215	BTA-15006060	229	BTA-20006060	278	
	72	8 1/2	BTA-12006072	280	BTA-15006072	272	BTA-20006072	357	
	84	10	BTA-12006084	350					
66	36	4	BTA-12006636	162	BTA-15006636	151	BTA-20006636	192	
	48	5 1/2	BTA-12006648	204	BTA-15006648	210	BTA-20006648	213	
	60	7	BTA-12006660	254	BTA-15006660	242	BTA-20006660	265	
72	30	3	BTA-12007230	144	BTA-15007230	149	BTA-20007230	155	
	36	4	BTA-12007236	156	BTA-15007236	162	BTA-20007236	195	
	48	5 1/2	BTA-12007248	245	BTA-15007248	212	BTA-20007248	228	
	60	7	BTA-12007260	315	BTA-15007260	269	BTA-20007260	326	
	72	8 1/2	BTA-12007272	355	BTA-15007272	386			
78	36	4	BTA-12007836	195	BTA-15007836	213	BTA-20007836	235	
	48	5 1/2	BTA-12007848	233	BTA-15007848	224	BTA-20007848	298	
	60	7	BTA-12007860	273	BTA-15007860	390	BTA-20007860	326	
	72	8 1/2	BTA-12007872	355	BTA-15007872	423			
84	36	4	BTA-12008436	228	BTA-15008436	232	BTA-20008436	244	
	48	5 1/2	BTA-12008448	253	BTA-15008448	257	BTA-20008448	314	
	60	7	BTA-12008460	267	BTA-15008460	321	BTA-20008460	390	
	72	8 1/2	BTA-12008472	375	BTA-15008472	372			



48 Hours
to Ship

Aluminum Truck Dockboards with Steel Safety Curbs

The Aluminum Truck Dockboard with Steel Safety Curbs is designed for portability and safety. The deck is made of tough high strength aluminum diamond tread plate. The edges are beveled for smooth entry and exit. Safety curbs are coated yellow and are constructed of steel with cast tapered ends. Steel legs are bolted on for increased durability. Legs are located 12" from the beveled edge. The legs are canted for easier fork truck portability. The bend is 11° and 9" from the beveled edge. Manufactured in compliance with OSHA. When using three-wheeled fork trucks order dockboard with capacity at least four-times the lifting capacity of fork truck.



48 Hours
to Ship

UNIFORM CAPACITY			10,000 LBS.		15,000 LBS.		20,000 LBS.	
Size (Inches) Width x Length	Ht. Difference 11° / 19° Inches		MODEL NUMBER	NET WT. (LBS.)	MODEL NUMBER	NET WT. (LBS.)	MODEL NUMBER	NET WT. (LBS.)
60 36	5		TAS-10-6036	100	TAS-15-6036	107	TAS-20-6036	110
60 48	7		TAS-10-6048	129	TAS-15-6048	146	TAS-20-6048	165
60 60	10		TAS-10-6060	160	TAS-15-6060	204	TAS-20-6060	218
60 72	12		TAS-10-6072	220	TAS-15-6072	251	TAS-20-6072	263
72 36	5		TAS-10-7236	110	TAS-15-7236	123	TAS-20-7236	123
72 48	7		TAS-10-7248	157	TAS-15-7248	191	TAS-20-7248	191
72 60	10		TAS-10-7260	223	TAS-15-7260	238	TAS-20-7260	253

Dockboard Accessories

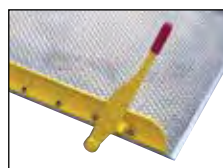

LEVERLIFT
model ALL



LIFTING CHAINS
series LC



SLIDING SPAN LOCKS
model SSL



WHEEL & HANDLE KIT
model WHHDL



ALUMINUM DOCKBOARD ACCESSORIES			
MODEL NUMBER	DESCRIPTION	MODEL NUMBER	DESCRIPTION
LC48-66	Lifting Chains 48"W - 66"W	HOLE	Extra Span Holes
LC72-84	Lifting Chains 72"W - 84"W	PIN	Extra Span Pins
SSL	Sliding Span Locks (BTA only)	ALL	Leverlift
WH	Dockboard Wheels Kit (125 lb. capacity)	RPL	Removable Pickup Loops (TS series only)
HDL	Dockboard Handle Kit	ATC	Anti-Theft Chain
WHHDL	Wheels & Handle Kit (125 lb. capacity)	SB	Second Bend
SP	Span Pins & Holes (4 holes per side)		

Aluminum Hand Truck Dockboards

The Aluminum Hand Truck Dockboards are lightweight and can be carried and positioned by one person. Provides a safe and convenient bridge between dock and truck. Welded aluminum diamond tread plate surface and beveled edges provide safe and smooth entry and exit. The bend is designed to keep ramp edges flush with the dock surface and the truck floor. The unit is equipped with welded on locking legs and full length aluminum curbs that provide hand holds and reduce chance of roll off. 800 pound uniform capacity. Designed for use with two-wheeled hand trucks. 3/16" plate thickness. Manufactured in compliance with OSHA.

MODEL NUMBER	OVERALL WIDTH	USABLE WIDTH	OVERALL LENGTH	HEIGHT DIFFERENTIAL	NET WT. (POUNDS)
AHTD-3036	30"	28"	36"	5"	35
AHTD-3048	30"	28"	48"	7"	46
AHTD-3648	36"	34"	48"	7"	51
AHTD-3660	36"	34"	60"	10"	65
AHTD-3672	36"	34"	72"	13"	75
AHTD-3696	36"	34"	96"	19"	107



48 Hours
to Ship

DESIGNED FOR USE
WITH TWO WHEEL
HAND TRUCKS
(not included)

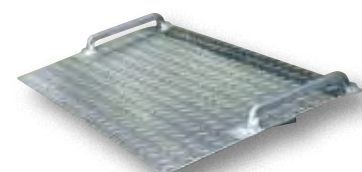
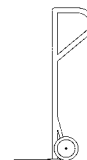

series AMD



48 Hours
to Ship



Aluminum Mini Dockplates

The Aluminum Mini Dockplate can scale 3" to 6" high curbs and door thresholds. Ideal for use with two-wheeled hand truck for deliveries. Aluminum construction is lightweight yet durable, 1/8" thick plate. Features carrying handles and diamond tread plate surface for better traction.

MODEL NUMBER	OVERALL WIDTH	USABLE WIDTH	OVERALL LENGTH	MAXIMUM SINGLE AXL CAPACITY	UNIFORM CAPACITY	NET WT. (POUNDS)
AMD-2418	24"	21½"	18"	400 lbs.	500 lbs.	9
AMD-3018	30"	27½"	18"	400 lbs.	600 lbs.	10
AMD-3618	36"	33½"	18"	400 lbs.	700 lbs.	11



LEVERLIFT STANDARD

Steel Truck Dockboards

The Steel Truck Dockboard is constructed of high strength (55,000 psi) steel for long life. Beveled edges on both ends permit smooth entry and exit. Deck is diamond plated for safe, efficient use. Welded safety curbs for maximum strength. Locking legs minimize ramp movement and are uneven to allow the dockboard to sit canted for easier floor pickup by fork trucks when not in use. Legs are located 12" from the edge of the dockboard. The bend is 11 degrees and 9 inches from beveled edge. Standard with Lever Lift for quick portability with fork truck. Manufactured in compliance with OSHA. Optional accessories: lifting chains, span locks, span pins/holes, and removable pickup loops.

UNIFORM CAPACITY			10,000 LBS.		15,000 LBS.		20,000 LBS.	
Size (Inches) Width x Length	Ht. Difference 11° / 19% Inches		MODEL NUMBER	NET WT. (LBS.)	MODEL NUMBER	NET WT. (LBS.)	MODEL NUMBER	NET WT. (LBS.)
60 36	5		TS-10-6036	259	TS-15-6036	295	TS-20-6036	303
60 48	7		TS-10-6048	388	TS-15-6048	390	TS-20-6048	433
60 60	10		TS-10-6060	447	TS-15-6060	458	TS-20-6060	582
60 72	12		TS-10-6072	535	TS-15-6072	601	TS-20-6072	791
66 36	5		TS-10-6636	318	TS-15-6636	353	TS-20-6636	359
66 48	7		TS-10-6648	424	TS-15-6648	461	TS-20-6648	421
66 72	12		TS-10-6672	647	TS-15-6672	686	TS-20-6672	768
72 36	5		TS-10-7236	300	TS-15-7236	347	TS-20-7236	390
72 48	7		TS-10-7248	386	TS-15-7248	386	TS-20-7248	512
72 54	8-1/2		TS-10-7254	556	TS-15-7254	505	TS-20-7254	641
72 60	10		TS-10-7260	563	TS-15-7260	552	TS-20-7260	647
72 72	12		TS-10-7272	721	TS-15-7272	668	TS-20-7272	919
84 36	5		TS-10-8436	346	TS-15-8436	393	TS-20-8436	449
84 48	7		TS-10-8448	567	TS-15-8448	507	TS-20-8448	548
84 60	10		TS-10-8460	671	TS-15-8460	648	TS-20-8460	730
Size (Inches) Width x Length	Ht. Difference 11° / 19% (In)		25,000 LBS.		30,000 LBS.			
60 36	5		TS-25-6036	447	TS-30-6036	467		
60 48	7		TS-25-6048	562	TS-30-6048	485		
60 60	10		TS-25-6060	695	TS-30-6060	738		
60 72	12		TS-25-6072	791	TS-30-6072	952		
66 36	5		TS-25-6636	483	TS-30-6636	554		
66 48	7		TS-25-6648	516	TS-30-6648	730		
66 72	12		TS-25-6672	855	TS-30-6672	1032		
72 36	5		TS-25-7236	437	TS-30-7236	507		
72 48	7		TS-25-7248	547	TS-30-7248	688		
72 54	8-1/2		TS-25-7254	628	TS-30-7254	750		
72 60	10		TS-25-7260	807	TS-30-7260	833		
72 72	12		TS-25-7272	859	TS-30-7272	1111		
84 36	5		TS-25-8436	563	TS-30-8436	681		
84 48	7		TS-25-8448	741	TS-30-8448	858		
84 60	10		TS-25-8460	878	TS-30-8460	1007		

- Standard with Lever Lift
- Chain Pickup and Use Suffix (-C) (no leverlift)
- Span Locks and Use Suffix (-SL)
- Call Us for Special Sizes and Configurations.

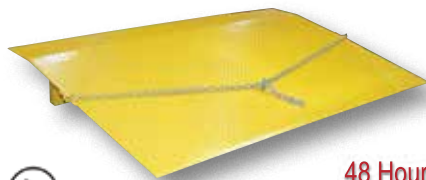

Steel Truck Dockplates

The Steel Truck Dockplate is constructed of high strength INX-55 (55,000 psi) steel. Safety locking legs prevent slippage between truck and dock. Safety tread plate helps provide positive traction. Beveled edges for smooth entry and exit. Chain pickup comes standard. Designed with an 11° bend located 9" from the beveled edge. The legs are 12" from the beveled edge. Manufactured in compliance with OSHA. When using three-wheeled pallet trucks, select capacity +20% due to concentrated load center of board.



OVERALL WIDTH	OVERALL LENGTH	HEIGHT DIFF.	3/8" PLATE THICKNESS			1/2" PLATE THICKNESS		
			MODEL NUMBER	UNIFORM CAPACITY (POUNDS)	NET WT. (LBS.)	MODEL NUMBER	UNIFORM CAPACITY (POUNDS)	NET WT. (LBS.)
48"	30"	4"	SE-4830	5,000	177	SEH-4830	8,800	227
48"	36"	5"	SE-4836	4,125	215	SEH-4836	7,300	263
48"	48"	7"	SE-4848	3,090	324	SEH-4848	5,500	429
48"	60"	9"	SE-4860	2,475	341	SEH-4860	4,400	528
54"	30"	4"	SE-5430	5,500	235	SEH-5430	9,900	253
54"	36"	5"	SE-5436	4,600	277	SEH-5436	8,250	371
54"	48"	7"	SE-5448	3,450	304	SEH-5448	6,185	486
54"	60"	9"	SE-5460	2,760	444	SEH-5460	4,950	575
60"	36"	5"	SE-6036	5,150	261	SEH-6036	9,160	317
60"	48"	7"	SE-6048	3,860	362	SEH-6048	6,875	445
60"	60"	9"	SE-6060	3,090	498	SEH-6060	5,500	554

Aluminum Wheel Risers

Elevate semi-trailers to loading docks for maximum serviceability during loading and unloading operations. Manufactured from heavy-duty aluminum tread plate for positive traction. All welded aluminum construction. 30,000 lbs. uniform capacity per pair (1/4" thick material). Wheel Risers are designed to raise the trailer for loading and unloading to facilitate compliance with OSHA/ANSI B56.1 part 3 sec 7 requirements for maximum grade of ascending or descending loaded fork trucks.

48 Hours
to Ship

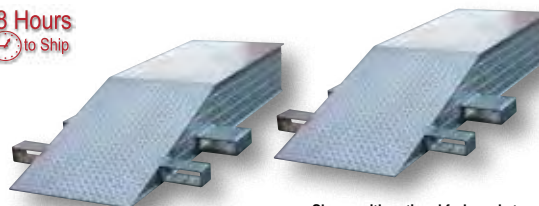

Shown with optional fork pockets

HEIGHT	OVERALL LENGTH	LEVEL LENGTH	18" USABLE WIDTH		24" USABLE WIDTH	
			MODEL NUMBER	NET WT. (EACH)	MODEL NUMBER	NET WT. (EACH)
6"	48"	30"	ATWR-18-6-48	41	ATWR-24-6-48	59
	54"	36"	ATWR-18-6-54	46	ATWR-24-6-54	60
	60"	42"	ATWR-18-6-60	87	ATWR-24-6-60	110
	102"	84"	ATWR-18-6-102	122	ATWR-24-6-102	162
8"	54"	30"	ATWR-18-8-54	56	ATWR-24-8-54	112
	60"	36"	ATWR-18-8-60	98	ATWR-24-8-60	122
	108"	84"	ATWR-18-8-108	148	ATWR-24-8-108	194
10"	60"	30"	ATWR-18-10-60	108	ATWR-24-10-60	133
	66"	36"	ATWR-18-10-66	111	ATWR-24-10-66	142
	114"	84"	ATWR-18-10-114	175	ATWR-24-10-114	229
12"	66"	30"	ATWR-18-12-66	125	ATWR-24-12-66	160
	72"	36"	ATWR-18-12-72	131	ATWR-24-12-72	169
	78"	42"	ATWR-18-12-78	144	ATWR-24-12-78	191
	120"	84"	ATWR-18-12-120	208	ATWR-24-12-120	270



PORTABILITY KIT, model ATWR-WL, allows one person to transport and place wheel riser. Features 5" x 2" mold-on-rubber wheels. For use with aluminum wheel risers only.

ADD A WHEEL TO A SINGLE ALUMINUM WHEEL RISER FOR PORTABILITY. MODEL ATWR-WL
 OPTIONAL WELDED FORK POCKETS, 7 1/2"W x 2 1/2"H, MODEL ATWR-FP
 PORTABLE WHEEL RISER CADDY, MODEL R-CAD-18, for 18" wide units, (2 pair of brackets)
 PORTABLE WHEEL RISER CADDY, MODEL R-CAD-24, for 24" wide units, (2 pair of brackets)
 PAIR OF BOLT-ON BRACKETS AND HARDWARE, MODEL R-CAD-KIT
 ANCHOR BRACKETS (4 PER RISER) TO BOLT RISER TO GROUND, MODEL ATWR-ABRK

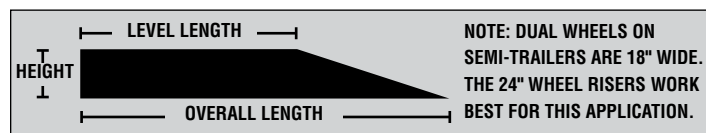

Steel Wheel Risers

WHEEL RISERS ARE PRICED AND SOLD EACH

The Steel Wheel Riser is equipped with fork slots for ease in fork truck transporting. Ramps may be stacked for compact storage when not in use. Fork pockets are 7 1/2" wide by 2 1/2" high usable. These fork pockets add approximately 15" to the overall width of the riser. Wheel Risers are designed to raise the trailer for loading and unloading to facilitate compliance with OSHA/ANSI B56.1 part 3 sec 7 requirements for maximum grade of ascending or descending loaded fork trucks. Made of heavy-duty welded steel construction. Uniform capacity per pair is 40,000 lbs. (1/4" thick material). Units over 168" long are built and ship in two (2) pieces.



model R-CAD-KIT



PORTABLE WHEEL RISER CADDY, series R-CAD, move steel or aluminum risers out of the way with this easy to use mover. Snap roller into riser and away you go.

HEIGHT	OVERALL LENGTH	LEVEL LENGTH	18" USABLE WIDTH		24" USABLE WIDTH	
			MODEL NUMBER	NET WT. (EACH)	MODEL NUMBER	NET WT. (EACH)
6 1/4"	48"	24"	SWR-18-6-48	233	SWR-24-6-48	218
	60"	36"	SWR-18-6-60	255	SWR-24-6-60	266
	72"	48"	SWR-18-6-72	296	SWR-24-6-72	310
	84"	60"	SWR-18-6-84	353	SWR-24-6-84	363
8 1/4"	60"	28"	SWR-18-8-60	324	SWR-24-8-60	271
	72"	40"	SWR-18-8-72	347	SWR-24-8-72	334
	96"	64"	SWR-18-8-96	445	SWR-24-8-96	416
10 1/4"	60"	20"	SWR-18-10-60	237	SWR-24-10-60	330
	72"	32"	SWR-18-10-72	300	SWR-24-10-72	361
	96"	56"	SWR-18-10-96	392	SWR-24-10-96	486
12 1/4"	72"	24"	SWR-18-12-72	360	SWR-24-12-72	428
	84"	36"	SWR-18-12-84	425	SWR-24-12-84	499
	96"	48"	SWR-18-12-96	450	SWR-24-12-96	537
	108"	60"	SWR-18-12-108	503	SWR-24-12-108	581

PORTABLE WHEEL RISER CADDY, MODEL R-CAD-18, for 18" wide units, (2 pair of brackets)
 PORTABLE WHEEL RISER CADDY, MODEL R-CAD-24, for 24" wide units, (2 pair of brackets)
 TWO PAIR OF WELD-ON BRACKETS AND HARDWARE, MODEL R-CAD-KIT (FACTORY INSTALLED)
 ANCHOR BRACKETS (4 PER RISER) TO BOLT RISER TO GROUND, MODEL SWR-ABRK, (FACTORY INSTALLED)
 CENTRAL PICKUP LOOP, MODEL SWR-CPL, (FACTORY INSTALLED), ADDITIONAL NET WT. 186 LBS.



CENTRAL PICK-UP LOOP, model SWR-CPL, is used to connect two wheel risers (factory installed). Allows fork trucks to easily position and move risers as one. Overall width is 102".

Aluminum Walk Ramps

The Aluminum Walk Ramp enables delivery personnel, shippers, and receivers to load and unload trucks when docks are unavailable. Ramps feature a 1½" high safety curb on each side. Heavy-duty steel chains with steel grab hooks are attached to each side of ramp for safely securing ramp to truck. Constructed of strong aluminum alloy with non-skid tread surface. The ramp is lightweight and easy to handle. Available in either an overlapping style that rests on the truck bed, suffix "A", or steel hook style that mounts onto the truck extensions, suffix "B".



TYPE A - OVERLAP



TYPE B - STEEL HOOKS



DECK CROSS-SECTION

TYPE	HEIGHT RANGE	LENGTH	UNIFORM CAPACITY (LBS.)		28" WIDE / 26" USABLE		38" WIDE / 36" USABLE	
			4-WHEEL CART	2-WHEEL CART	MODEL NUMBER	NET WT. (LBS.)	MODEL NUMBER	NET WT. (LBS.)
A	6" - 21"	6'	2,800	2,000	AWR-28-6A	68	AWR-38-6A	86
A	6" - 25"	7'	2,800	1,800	AWR-28-7A	78	AWR-38-7A	88
A	6" - 29"	8'	2,500	1,650	AWR-28-8A	84	AWR-38-8A	105
A	6" - 33"	9'	2,500	1,600	AWR-28-9A	95	AWR-38-9A	113
A	6" - 38"	10'	2,200	1,500	AWR-28-10A	101	AWR-38-10A	125
A	6" - 46"	12'	1,900	1,400	AWR-28-12A	128	AWR-38-12A	150
A	6" - 54"	14'	1,600	1,200	AWR-28-14A	136	AWR-38-14A	168
A	6" - 62"	16'	1,000	1,000	AWR-28-16A	153	AWR-38-16A	198
B	6" - 23"	6'	2,800	2,000	AWR-28-6B	68	AWR-38-6B	88
B	6" - 27"	7'	2,800	1,800	AWR-28-7B	78	AWR-38-7B	88
B	6" - 31"	8'	2,500	1,650	AWR-28-8B	84	AWR-38-8B	105
B	6" - 35"	9'	2,500	1,600	AWR-28-9B	95	AWR-38-9B	113
B	6" - 40"	10'	2,200	1,500	AWR-28-10B	105	AWR-38-10B	125
B	6" - 48"	12'	1,900	1,400	AWR-28-12B	128	AWR-38-12B	150
B	6" - 56"	14'	1,600	1,200	AWR-28-14B	136	AWR-38-14B	168
B	6" - 64"	16'	1,000	1,000	AWR-28-16B	154	AWR-38-16B	190

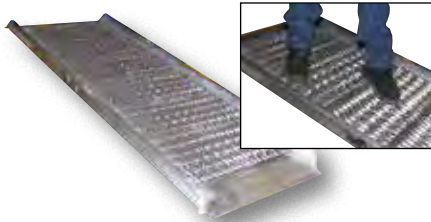

Aluminum Grip-Strut Walk Ramps

Load and unload trucks when docks are unavailable. The open deck design allows snow, ice, and water to fall through ramp providing a positive grip for delivery personnel, shippers, and receivers. One hundred percent welded aluminum construction is lightweight and will not rust. Ramps feature a 2" high safety curb on each side. Overlap style end lip rests on the trailer bed to provide a smooth transition. Each unit includes two (2) safety chains to connect the ramp to the trailer for safety. Not for pallet trucks or three-wheeled carts.

HEIGHT RANGE	LENGTH	UNIFORM CAPACITY (LBS.)		28" WIDE / 26" USABLE		38" WIDE / 36" USABLE	
		4-WHEEL CART	2-WHEEL CART	MODEL NUMBER	NET WT. (LBS.)	MODEL NUMBER	NET WT. (LBS.)
6" - 21"	6'	2,800	2,000	AWR-G-28-6A	41	AWR-G-38-6A	55
6" - 25"	7'	2,800	1,800	AWR-G-28-7A	59	AWR-G-38-7A	59
6" - 29"	8'	2,500	1,650	AWR-G-28-8A	61	AWR-G-38-8A	66
6" - 33"	9'	2,500	1,600	AWR-G-28-9A	63	AWR-G-38-9A	73
6" - 38"	10'	2,200	1,500	AWR-G-28-10A	68	AWR-G-38-10A	80
6" - 46"	12'	1,900	1,400	AWR-G-28-12A	77	AWR-G-38-12A	94
6" - 56"	14'	1,600	1,200	AWR-G-28-14A	89	AWR-G-38-14A	123
6" - 62"	16'	1,000	1,000	AWR-G-28-16A	122	AWR-G-38-16A	142

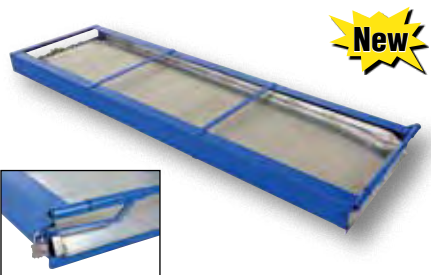

Aluminum Truck Mounted Walk Ramps

Ramp includes steel pocket frame for under-truck mounting. Frame includes linkage to prevent ramp from falling out. Manual spring-loaded lock secures ramp into frame. Handle loops are included to help with deploying the ramp. Overlap style end lip rests on trailer bed and provides smooth transition. Each unit includes two (2) safety chains to connect ramp to trailer for safety. Curb height is 2". Solid treadplate deck type features non-slip serrations for extra grip. The open grip-strut deck allows snow, ice, and water to fall thru ramp while the providing maximum traction. 100% welded aluminum construction is light-weight and will not rust.

HEIGHT RANGE	LENGTH	UNIFORM CAPACITY (LBS.)		TREADPLATE 28" WIDE / 26" USABLE		GRIP-STRUT 28" WIDE / 26" USABLE	
		4-WHEEL CART	2-WHEEL CART	MODEL NUMBER	NET WT. (LBS.)	MODEL NUMBER	NET WT. (LBS.)
6" - 46"	12'	1,900	1,400	AWR-TM-28-12A	203	AWR-TM-G-28-12A	150
6" - 54"	14'	1,600	1,200	AWR-TM-28-14A	231	AWR-TM-G-28-14A	177
6" - 62"	16'	1,000	1,000	AWR-TM-28-16A	255	AWR-TM-G-28-16A	209

Aluminum Walk Ramp Handrail Option

Aluminum Walk Ramp Handrail gives ramp users more stability and security. Railing sections are 42" high with a 21" mid-rail. Handrail can be bolted onto both A-style and B-style aluminum walk ramps. Handrail may be attached to one side or both sides of ramp. Aluminum construction with unpainted finish. Installation brackets and hardware included.

Ramp Cart Option, provides for easy one-person ramp positioning and transporting. Pull handle up to vertical position to rotate and lock wheels in down position. Push handle down to unlock and lift wheels so ramp can be used to service lower trailers. Hard rubber wheels measure 10" x 2½". Minimum ramp service height is 14" with this option. Easy bolt-on installation. Walk ramp sold separately.

Adjustable Height Wheel Option, is ideal for use with aluminum ramps 8 feet or longer. Height is adjusted with a manual hand crank mechanism. Wheels are 10" x 3½" pneumatic and are located at balance points on the ramp. Simple bolt-on installation. Minimum ramp lowered height with this option is 12". Walk ramp sold separately.

MODEL NUMBER	STYLE	HANDRAIL LENGTH	NET WT. (LBS.)
AWR-HR-2A	ALUMINUM BOLT-ON HANDRAIL KIT	2 FT.	15
AWR-HR-3A	ALUMINUM BOLT-ON HANDRAIL KIT	3 FT.	16
AWR-R-CART-28	RAMP CART OPTION		55
AWR-R-CART-38	RAMP CART OPTION		65
AWR-WHL	ADJUSTABLE HEIGHT WHEEL OPTION		180

series AWR-HR



model AWR-R-CART

model AWR-WHL

Heavy-Duty Fiberglass Walk Ramps

Load and unload equipment from trucks using these Heavy-Duty Fiberglass Walk Ramps. Reinforced fiberglass construction provides up to 3,000 pounds capacity. Abrasive surface provides good traction in wet or dry conditions. 1" high curb on each side of ramp. Not for use with fork trucks or pallet trucks.



ROUGH TEXTURE

MODEL NUMBER	OVERALL WIDTH	OVERALL LENGTH	UNIFORM CAPACITY	MAXIMUM WORKING HEIGHT	NET WT. (POUNDS)
FWR-3010-50	30"	10'	3,000 lbs.	30"	124
FWR-3012-50	30"	12'	3,000 lbs.	35"	161
FWR-3610-50	36"	10'	3,000 lbs.	30"	156
FWR-3612-50	36"	12'	3,000 lbs.	35"	180
FWR-3614-50	36"	14'	3,000 lbs.	45"	204

Fiberglass Autoloader Ramps

The Autoloader Ramp can be separated in half to provide two ramps that may be used to load automobiles and other vehicles. Each half is 18" wide and handles 2,500 pounds. To separate simply remove center hinge pins.

MODEL NUMBER	OVERALL WIDTH	OVERALL LENGTH	UNIFORM CAPACITY	MAXIMUM WORKING HEIGHT	NET WT. (POUNDS)
FAL-3610-50	36"	10'	5,000 lbs.	30"	162
FAL-3612-50	36"	12'	5,000 lbs.	35"	186
FAL-3614-50	36"	14'	5,000 lbs.	45"	210
FAL-3616-50	36"	16'	5,000 lbs.	50"	264

Aluminum Vehicle Twin Ramps

Provide a safe means for driving vans, pick-up trucks, and some passenger vehicles from ground level into and out of high building entrances. Ramps can be securely fastened to dock with pin locks. To avoid hang-ups, measure under clearance and wheelbase of vehicle. The overall width is 18" with a usable width of 14". Side curbs are 1¼" high. Welded aluminum construction.

MODEL NUMBER	OVERALL WIDTH	OVERALL LENGTH	UNIFORM CAPACITY	MAX to MIN WORKING HEIGHT	NET WT. (POUNDS)
VTR-7-14-8	18"	8'	7,000 lbs.	17½" to 12½"	62
VTR-5.5-14-10	18"	10'	5,500 lbs.	22½" to 16"	77
VTR-7-14-12	18"	12'	7,000 lbs.	27" to 19"	126
VTR-6-14-14	18"	14'	6,000 lbs.	32" to 22½"	144
VTR-5.5-14-16	18"	16'	5,500 lbs.	36½" to 25½"	166
VTR-6-14-18	18"	18'	6,000 lbs.	41" to 29"	201
VTR-5.5-14-20	18"	20'	5,500 lbs.	46" to 32½"	228
VTR-5.5-14-24	18"	24'	5,500 lbs.	55½" to 39"	288



Hitch Lift

Heavy-duty 12 volt DC motorized hitch lift. Standard 2" receiver bar has multiple pin positions for different tailgate depths (extends out 52" when lowered and 47" when raised). Built-in adjustable limiting device to allow the matching up of the deck plate to the truck bed level or to ground level. 21 foot long cable set for battery connection. Two stage outrigger assemblies for added stability. Be sure to fold the deck plate up before driving away. Tie down straps should be used to secure load. Steel construction.

MODEL NUMBER	PLATFORM SIZE (W x L)	RAMP (W x L)	UNIFORM CAPACITY (POUNDS)	NET WT. (LBS.)
HL-55 [Ⓢ]	28" x 25"	28" x 7"	500	187



Steel Container Ramps

Heavy duty steel container ramp facilitates easy loading/unloading of shipping containers when placed on ground level. Hinged flip-over bridge allows for easy transportation and compact storage. Tapered lip provides smooth transition into container at various heights. Built-in fork pockets in base for convenient fork truck positioning.

MODEL NUMBER	OVERALL WIDTH	OVERALL LENGTH	HEIGHT	UNIFORM CAPACITY (LBS.)	NET WT. (POUNDS)
SCR-72	76½"	98"	4-3/8"	15,000	816
SCR-84	88½"	98"	4-3/8"	15,000	924

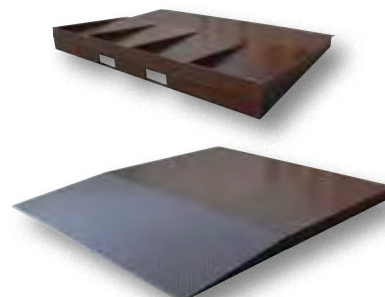

Container Step Platform

The Container Step Platform is used to lighten the burden of hand-unloading containers. The 21½"W x 21½"D x 46"H dual-coated railing help support your hips. The Platform has an aluminum anti-slip floor featuring deep ribbed plate. It has no sharp corners and is easy to maneuver due to smooth working ball bearings. The 4" non-marking polypropylene swivel spring loaded casters with rubber edges stabilize the platform when weight is added.

MODEL NUMBER	BOTTOM STEP (W x L x H)	TOP STEP (W x L x H)	UNIFORM CAPACITY (POUNDS)	NET WT. (LBS.)
CUP-3131 [Ⓢ]	31" x 31" x 8"	19½" x 19½" x 8"	485	106



Wheel Alignment Curbs

Ideal for properly aligning trailers at loading docks. All welded steel construction suitable for indoor or outdoor use. Units must be secured to surface. Heavy-duty welded-steel construction with yellow powder coat finish. 8" x 8" base plates with (8) pre-drilled holes standard.

MODEL NUMBER	HEIGHT	LENGTH	DIAMETER	NET WT. (POUNDS)
SWAC-92	8 ^{15/16} "	92"	4½"	81
SWAC-144	8 ^{15/16} "	147½"	4½"	173
AS-344	(1) ¾" x 4¼" CONCRETE ANCHOR BOLTS			1
AS-344-4PK	(4) ¾" x 4¼" CONCRETE ANCHOR BOLTS			4



Fabricated Aluminum Hose & Cable Bridges

Protect hoses and cables from carts and other traffic. Constructed of lightweight durable welded aluminum tread plate. All welded. The opening is available in spans of 4" to 16". (⅜" thick plate).

MODEL NUMBER	OVERALL SIZE (W x L)	USABLE SPAN (W x H)	UNIFORM CAPACITY (LBS.)	NET WT. (POUNDS)
FHCR-24-36-4	24" x 36"	4" x 3"	2,000	33
FHCR-24-40-8	24" x 40"	8" x 3"	2,000	38
FHCR-24-44-12	24" x 44"	12" x 3"	2,000	39
FHCR-24-48-16	24" x 48"	16" x 3"	2,000	44
FHCR-24-36-4-4H	24" x 36"	4" x 4"	2,000	83
FHCR-24-40-8-4H	24" x 40"	8" x 4"	2,000	85
FHCR-24-44-12-4H	24" x 44"	12" x 4"	2,000	43
FHCR-24-48-16-4H	24" x 48"	16" x 4"	2,000	90
FHCR-48-36-4	48" x 36"	4" x 3"	2,000	60
FHCR-48-40-8	48" x 40"	8" x 3"	2,000	115
FHCR-48-44-12	48" x 44"	12" x 3"	2,000	132
FHCR-48-48-16	48" x 48"	16" x 3"	2,000	128
FHCR-48-36-4-4H	48" x 36"	4" x 4"	2,000	121
FHCR-48-40-8-4H	48" x 40"	8" x 4"	2,000	137
FHCR-48-44-12-4H	48" x 44"	12" x 4"	2,000	129
FHCR-48-48-16-4H	48" x 48"	16" x 4"	2,000	133

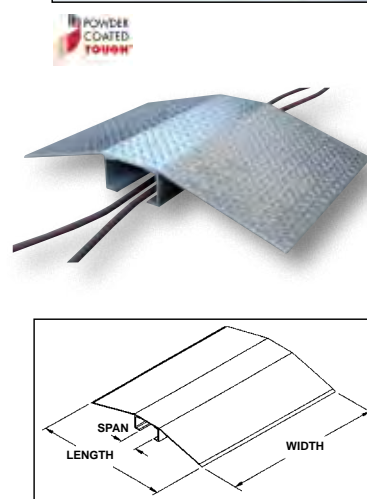



Extruded Aluminum Hose & Cable Bridges

Designed to protect cables and hoses from pedestrian and rolling traffic. Heavy duty aluminum construction is durable and attractive. Top surface of each bridge includes serrations for better traction. Each unit features a maximum capacity rating of 5,000 lbs. Contact factory for special lengths up to 25 feet.

OVERALL (W x H)	USABLE SPAN (W x H)	OVERALL LENGTH	NET WT. (LBS.)	ALUMINUM	BLACK	BROWN
				MODEL NUMBER	MODEL NUMBER	MODEL NUMBER
27/8" x 7/16"	1 1/4" x 5/16"	24"	2	WR-24	WR-24-BK	WR-24-BRN
		36"	4	WR-36	WR-36-BK	WR-36-BRN
		48"	5	WR-48	WR-48-BK	WR-48-BRN
7 1/8" x 1 1/8"	2 1/2" x 3/4"	24"	7	HCR-24	HCR-24-BK	HCR-24-BRN
		36"	8	HCR-36	HCR-36-BK	HCR-36-BRN
		48"	13	HCR-48	HCR-48-BK	HCR-48-BRN
9 1/8" x 1 1/2"	2 1/2" x 1 1/4"	36"	13	LHCR-36	LHCR-36-BK	LHCR-36-BRN
		48"	17	LHCR-48	LHCR-48-BK	LHCR-48-BRN
		60"	24	LHCR-60	LHCR-60-BK	LHCR-60-BRN
		72"	26	LHCR-72	LHCR-72-BK	LHCR-72-BRN
21 1/16" x 3 1/2"	4 1/2" x 3"	36"	51	XHCR-36	XHCR-36-BK	XHCR-36-BRN
		48"	58	XHCR-48	XHCR-48-BK	XHCR-48-BRN
		60"	72	XHCR-60	XHCR-60-BK	XHCR-60-BRN
		72"	88	XHCR-72	XHCR-72-BK	XHCR-72-BRN
				YELLOW	YELLOW / BLACK	
OVERALL (W x H)	USABLE SPAN (W x H)	OVERALL LENGTH	NET WT. (LBS.)	MODEL NUMBER	MODEL NUMBER	
27/8" x 7/16"	1 1/4" x 5/16"	24"	2	WR-24-Y	WR-24-YB	
		36"	4	WR-36-Y	WR-36-YB	
		48"	5	WR-48-Y	WR-48-YB	
7 1/8" x 1 1/8"	2 1/2" x 3/4"	24"	7	HCR-24-Y	HCR-24-YB	
		36"	8	HCR-36-Y	HCR-36-YB	
		48"	13	HCR-48-Y	HCR-48-YB	
9 1/8" x 1 1/2"	2 1/2" x 1 1/4"	36"	13	LHCR-36-Y	LHCR-36-YB	
		48"	17	LHCR-48-Y	LHCR-48-YB	
		60"	24	LHCR-60-Y	LHCR-60-YB	
		72"	26	LHCR-72-Y	LHCR-72-YB	
21 1/16" x 3 1/2"	4 1/2" x 3"	36"	51	XHCR-36-Y	XHCR-36-YB	
		48"	58	XHCR-48-Y	XHCR-48-YB	
		60"	72	XHCR-60-Y	XHCR-60-YB	
		72"	88	XHCR-72-Y	XHCR-72-YB	

48 Hours to Ship

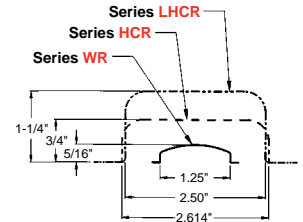

Urethane Hose & Cable Bridges

Protect hoses and cables from everyday foot traffic. Handles loads up to 100 PSI (2,400 pounds) with less than 10% deflection. Constructed of durable urethane material. Designed with traction cleats on ramp surface to prevent slippage (for light traffic and slow applications only).

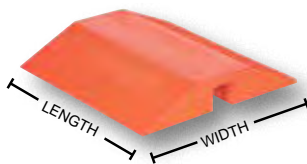

48 Hours to Ship

MODEL NUMBER	OVERALL SIZE (W x L)	USABLE SPAN (W x H)	UNIFORM CAPACITY (POUNDS)	NET WT. (POUNDS)
URTH-24	23 1/2" x 24"	3" x 3"	2,400	18
URTH-36	23 1/2" x 36"	3" x 3"	2,400	35
URTH-48	23 1/2" x 48"	3" x 3"	2,400	39



Multi-Channel Cable Protectors

The fast and easy way to guard and protect valuable electrical cables and hose lines from damage and abuse while providing a method of safe crossing for vehicle and pedestrian traffic. Three channel design is ideal for construction sites, sporting events, and warehouses. Constructed of synthetic rubber with a yellow plastic lid. Ends include interlocking tabs for creating longer assemblies. Maximum weight loading capacity is 20,000 lbs.

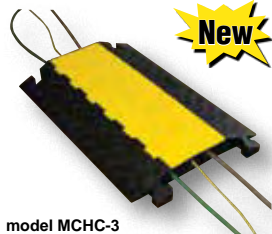

model MCHC-3

48 Hours to Ship

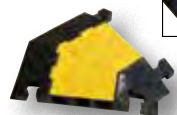
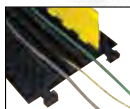

model MCHC-3L

MODEL NUMBER	DESCRIPTION	CHANNEL SIZE (W x H)	OVERALL SIZE (W x L x H)	NET WT. (LBS.)
MCHC-3	3-Channel CENTER Section	2 3/8" x 2"	23 1/2" x 35 1/2" x 3"	55
MCHC-3L	3-Channel LEFT Section	2 3/8" x 2"	23 1/2" x 24 1/2" x 3"	28
MCHC-3R	3-Channel RIGHT Section	2 3/8" x 2"	23 1/2" x 24 1/2" x 3"	28
MCHC-3END	3-Channel End Caps ONE PAIR	2 3/8" x 2"	23 1/2" x 8" x 3"	21
MCHC-5	5-Channel CENTER Section	1 1/2" x 2"	23 1/2" x 35 1/2" x 3"	55
MCHC-5L	5-Channel LEFT Section	1 1/2" x 2"	23 1/2" x 24 1/2" x 3"	28
MCHC-5R	5-Channel RIGHT Section	1 1/2" x 2"	23 1/2" x 24 1/2" x 3"	28
MCHC-5END	5-Channel End Caps ONE PAIR	1 1/2" x 2"	23 1/2" x 8" x 3"	21

Molded Rubber Hose & Cable Bridges

Designed to protect cables and hoses from pedestrian and rolling traffic. The top surface of each bridge includes serrations for extra traction. Optional connectors may be used to interlock individual units together to form wider bridges. Simply lock together as many units as required.

Model MRBR-24 has carrying handles molded into the ramp.

Fits over cables to protect hoses from punctures and kinks.

*Series RHC*B is ideal for people who are always switching out cables, but do not want to move the ramp. The model RHC-B-A features an aluminum tread plate insert to protect hoses and cables (for light traffic and slow applications only).

MODEL NUMBER	OVERALL SIZE (W x L)	USABLE SPAN (W x H)	UNIFORM CAPACITY (POUNDS)	NET WT. (POUNDS)
MRBR-24 [Ⓢ]	24" x 23¼"	2¾" x 1½"	2,400	48
MRBR-CON [Ⓢ]		CONNECTOR PER PAIR		3
RHC-B-12 [Ⓢ]	12" x 32 ⁵ / ₈ "	3½" x 2 ⁷ / ₈ "	2,400	33
RHC-B-12A [Ⓢ]	12" x 32 ⁵ / ₈ "	3½" x 3"	2,400	38
RHC-B-CON [Ⓢ]		CONNECTOR PER PAIR		2



CONNECTORS

48 Hours
to Ship

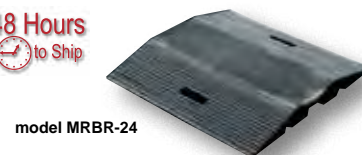

model MRBR-24

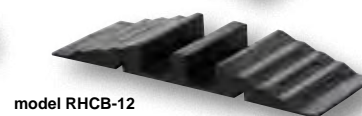

model RHC-B-12

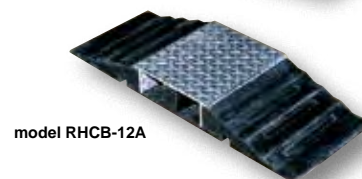

model RHC-B-12A

48 Hours
to Ship

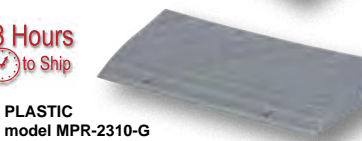
PLASTIC
model MPR-2310-G

BRIDGE KIT

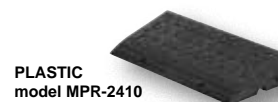
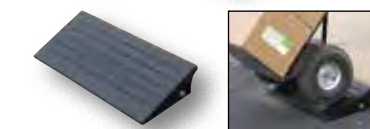
PLASTIC
model MPR-2410

SOLID RUBBER, model MRR-2310

48 Hours
to Ship

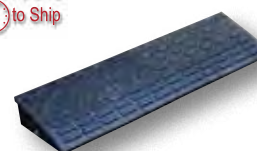

model RCR-35



model RCR-C

Multi-Purpose Ramps

High impact ramps are perfect for a variety of work environments; postal routes, schools, hospitals, warehouses, and delivery routes. These ramps make it simple to move loads onto a curb or over hoses and cables. The textured non-skid surface allows for sure footing on the incline and decline. The lightweight and completely portable unit handles hand trucks and other wheeled equipment with ease.

MODEL NUMBER	MATERIAL	WIDTH	LENGTH	HEIGHT	UNIFORM CAPACITY	NET WT. (LBS.)
MPR-2310-G [Ⓢ]	PLASTIC	23¼"	10½"	3 ¹¹ / ₁₆ "	5,000 lbs.	6
MPR-2313-G [Ⓢ]	PLASTIC	23¼"	13¼"	5½"	5,000 lbs.	8
MPR-2410 [Ⓢ]	PLASTIC	24"	10 ⁵ / ₈ "	3 ⁷ / ₈ "	5,000 lbs.	7
MRR-2310 [Ⓢ]	RUBBER	23¼"	10½"	3 ¹¹ / ₁₆ "	5,000 lbs.	21
MPR-10-KIT [Ⓢ]	OPTIONAL BRIDGE KIT FOR MPR-2310-G, MPR-2410 or MRR-2310					6
MPR-13-KIT [Ⓢ]	OPTIONAL BRIDGE KIT FOR MPR-2313-G					6

Rubber Ramps

Modular Rubber Ramps are versatile for use in many applications. Two (2) ramp lengths to choose from. Add round corner pieces for a finished look. Tread surface pattern for better traction. Includes hardware for connecting ramps together. Uniform capacity is 4,000 pounds per ramp. Heavy-duty molded rubber construction.

MODEL NUMBER	DESCRIPTION	WIDTH	DEPTH	HEIGHT	NET WT. (LBS.)
RCR-23 [Ⓢ]	RECTANGULAR RAMP	23 ⁵ / ₈ "	9 ¹¹ / ₁₆ "	3 ⁵ / ₈ "	16
RCR-35 [Ⓢ]	RECTANGULAR RAMP	34 ⁷ / ₈ "	9 ¹¹ / ₁₆ "	3 ⁵ / ₈ "	26
RCR-C [Ⓢ]	CORNER RAMP	9 ¹¹ / ₁₆ "	9 ¹¹ / ₁₆ "	3 ⁵ / ₈ "	28

Cable Guard

Designed to protect hose and cable from roll-over damage. Ideal for office and pedestrian applications. Interlocking design connects units for longer lengths. Top surface of ramp features anti-slip traction design. Manufactured from black molded rubber.

MODEL NUMBER	COLOR	OVERALL SIZE (W x L x H)	USABLE SPAN (W x H)	UNIFORM CAPACITY (LBS.)	NET WT. (LBS.)
MRHR-39 [Ⓢ]	BLACK	5" x 39" x 3/4"	1 ⁷ / ₁₆ " x ½"	2,200	4
MRHR-39-YL [Ⓢ]	YELLOW	5" x 39" x 3/4"	1 ⁷ / ₁₆ " x ½"	2,200	4
MRHR-39-BG [Ⓢ]	BEIGE	5" x 39" x 3/4"	1 ⁷ / ₁₆ " x ½"	2,200	4

48 Hours
to Ship

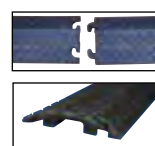
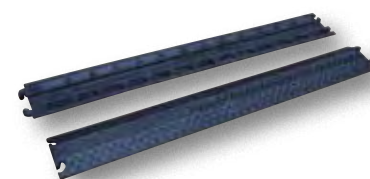

Long Extruded Rubber Cable Protectors

This product works well for temporary wire/cable protection from vehicles.

MODEL NUMBER	WIDTH (INCHES)	LENGTH (FEET)	HEIGHT (INCHES)	TOP OPENING	TWO BOTTOM OPENINGS	UNIFORM CAPACITY	NET WT. (LBS.)
C-75-12 [Ⓢ]	4"	12	1¼"	½"	5/8"	6,600 lbs.	16
C-75-24 [Ⓢ]	4"	24	1¼"	½"	5/8"	6,600 lbs.	33
C-150-12 [Ⓢ]	6½"	12	2¼"	1½"	½"	4,400 lbs.	39

48 Hours
to Ship

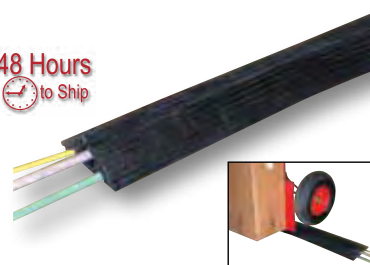

model C-75-24



Sidewinder Cable Protector

The Sidewinder Cable Protector is an innovative new solution for protecting cables that run across a floor. The new design articulates left and right allowing the system to turn corners and adapt to the layout of the room, while maintaining full protection for the cables and trip protection for pedestrians. The cables can be left in the system and coiled around a three foot diameter for ultimate portability, or left in place indefinitely. There is no longer a compromise between safety and flexibility.



MODEL NUMBER	COLOR	END CAPS INCLUDED	OVERALL SIZE (W x L x H)	USABLE SPAN (W x H)	NET WT. (LBS.)
SWCP-3-YB	Yellow/Black	Yes	3" x 40" x 3/4"	3/4" x 3/8"	6
SWCP-1X-YB	Yellow/Black	No	3" x 12" x 3/4"	3/4" x 3/8"	4
SWCP-3-BK	Black	Yes	3" x 40" x 3/4"	3/4" x 3/8"	6
SWCP-1X-BK	Black	No	3" x 12" x 3/4"	3/4" x 3/8"	4
SWCP-3-BRN	Brown	Yes	3" x 40" x 3/4"	3/4" x 3/8"	6
SWCP-1X-BRN	Brown	No	3" x 12" x 3/4"	3/4" x 3/8"	4
SWCP-3-GY	Grey	Yes	3" x 40" x 3/4"	3/4" x 3/8"	6
SWCP-1X-GY	Grey	No	3" x 12" x 3/4"	3/4" x 3/8"	4
SWCP-3-YB-M	Yellow/Black	No	9 3/4" x 40" x 1 3/8"	3" x 3/4"	7
SWCP-1X-YB-M	Yellow/Black	No	9 3/4" x 12" x 1 3/8"	3" x 3/4"	3
SWCP-3-BK-M	Black	No	9 3/4" x 40" x 1 3/8"	3" x 3/4"	7
SWCP-1X-BK-M	Black	No	9 3/4" x 12" x 1 3/8"	3" x 3/4"	3
SWCP-3-BRN-M	Brown	No	9 3/4" x 12" x 1 3/8"	3" x 3/4"	7
SWCP-1X-BRN-M	Brown	No	9 3/4" x 12" x 1 3/8"	3" x 3/4"	3
SWCP-3-GY-M	Grey	No	9 3/4" x 12" x 1 3/8"	3" x 3/4"	7
SWCP-1X-GY-M	Grey	No	9 3/4" x 12" x 1 3/8"	3" x 3/4"	3
SWCP-3-YB-L	Yellow/Black	No	13 5/8" x 40" x 2 1/8"	3" x 1 1/2"	14
SWCP-1X-YB-L	Yellow/Black	No	13 5/8" x 12" x 2 1/8"	3" x 1 1/2"	5
SWCP-3-BK-L	Black	No	13 5/8" x 40" x 2 1/8"	3" x 1 1/2"	14
SWCP-1X-BK-L	Black	No	13 5/8" x 12" x 2 1/8"	3" x 1 1/2"	5



Heavy Duty LED Dock Loading Lights 115V 1-PHASE STANDARD

Rugged, heavy duty LED Dock Loading Lights provides brighter light than an incandescent light source while only using 18 watts of power. Encased in a cast aluminum housing with shatter resistant polycarbonate lens cover, this unit instantly reaches maximum light output. Light head is IP66 rated; can be sprayed down. Expected life of 50,000+ hours; 3 year warranty. UL listed.

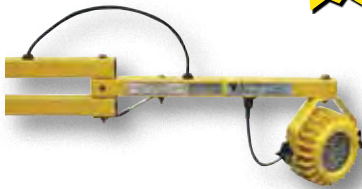

MODEL NUMBER	DESCRIPTION	ARM LENGTH	LIGHT BULB INCLUDED	NET WT. (LBS.)
LL-HD-LED-24	SINGLE ARM	24"	YES	17
LL-HD-LED-40	DOUBLE ARM	40"	YES	25
LL-HD-LED-60	DOUBLE ARM	60"	YES	28
LL-HD-LED-90	DOUBLE ARM	90"	YES	38



model LL-LED-40



LED Dock Loading Lights 115V 1-PHASE STANDARD

Reduce broken bulb and high maintenance costs with LED Dock Loading Lights. These use 80% less energy than incandescent or halogen bulbs. Achieves maximum light intensity instantly, and light is optimized for trailer illumination. These LED lights have no fragile filaments to break, eliminating the shattered glass of broken incandescent bulbs. Light bulb included.

MODEL NUMBER	DESCRIPTION	ARM LENGTH	LIGHT BULB INCLUDED	NET WT. (LBS.)
LL-LED-24 [®]	SINGLE STRUT	24"	YES	11
LL-LED-40 [®]	DOUBLE STRUT	40"	YES	15
LL-LED-60 [®]	DOUBLE STRUT	60"	YES	18
LL-LED-BULB [®]	REPLACEMENT LED BULB			2



model LL-GN-27

Flexible Gooseneck Incandescent Dock Light 115V 1-PHASE STANDARD

Low profile, flexible task light, ideally suited for loading dock applications. Its 27" flexible stainless steel neck can be easily rotated and positioned to light with minimal obstruction to the loading dock area. The dock lights narrow profile and flexibility enable it to be mounted between two (2) neighboring loading dock positions. With the simple mounting method and ability to be positioned precisely, it is an ideal task light for use around work stations and machinery. UL listed.



model LL-GN-LED-27

MODEL NUMBER	DESCRIPTION	ARM LENGTH	LIGHT BULB INCLUDED	NET WT. (LBS.)
LL-GN-27	INCANDESCENT (90 WATT)	27"	NO	10
LL-GN-LED-27	LED	27"	YES	10

Dock Loading Lights 115V 1-PHASE STANDARD

Lights minimize freight damage, while expediting loading and unloading operations. Designed to provide uniform visibility inside trailers or around dock areas. Model LL-SAI and LL-SAF are ETL C/U.S. listed, while all others are UL listed.



Incandescent Lights, series LL. offer good color, low replacement cost, and turn on instantly even in cold environments. It utilizes a 90 watt bulb, model *PAR-38-90*, sold separately. Adjustable arm knuckle joint allows vertical and horizontal positioning.

Halogen Light, model HLGN-40, typically provides more lumens/watt, better energy efficiency, has a longer service life, and experiences less light depreciation over its lifetime. It is supplied with a 500 watt bulb. Full illumination is instantaneous.

High Pressure Sodium Lights, series LLS and AALLS, offer much higher lumens/watt output and a very long lamp life. Its illumination color rendition (yellowish) is not as desirable as an incandescent. They typically require several minutes to fully illuminate, and even longer if in a cold environment. Low operating cost.

Spun Aluminum Dock Lights, series LL-SAI, stay cool to the touch even with a 300 watt incandescent light. Features strut arm with both horizontal and vertical adjustment. Available in a standard incandescent lamp head and a fluorescent lamp head. Fluorescent units include a bulb and head.



INCANDESCENT
SINGLE ARM
model LL-24



INCANDESCENT
DOUBLE ARM
model LL-40

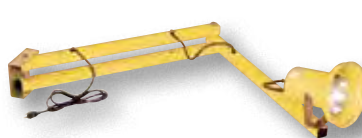

INCANDESCENT
DOUBLE ARM
model LL-60



HALOGEN
DOUBLE ARM
model HLGN-40

	MODEL NUMBER	DESCRIPTION	LENGTH	NET WT. (POUNDS)
DRY LOCATIONS	LL-24	INCANDESCENT, SINGLE ARM	24"	14
	LL-40	INCANDESCENT, DOUBLE ARM	40"	16
	LL-60	INCANDESCENT, DOUBLE ARM	60"	21
	LL-90	INCANDESCENT, TRIPLE ARM	90"	30
	LL-SAI-40	INCANDESCENT, SINGLE STRUT ARM	40"	11
	LL-SAI-60	INCANDESCENT, SINGLE STRUT ARM	60"	15
	HLGN-40	HALOGEN, DOUBLE ARM	40"	6
DAMP LOCATIONS	LL-SAF-40	FLUORESCENT, SINGLE STRUT ARM	40"	11
	LL-SAF-60	FLUORESCENT, SINGLE STRUT ARM	60"	15
	LLS-24	HIGH PRESSURE SODIUM, SINGLE ARM	24"	10
	LLS-40	HIGH PRESSURE SODIUM, DOUBLE ARM	40"	18
	LLS-60	HIGH PRESSURE SODIUM, DOUBLE ARM	60"	21
	LLS-90	HIGH PRESSURE SODIUM, TRIPLE ARM	90"	30
	AALLS-40	HIGH PRESSURE SODIUM, ADJUSTABLE ARM	40"	17
AALLS-60	HIGH PRESSURE SODIUM, ADJUSTABLE ARM	60"	19	



INCANDESCENT
series LL-SAI



FLUORESCENT
series LL-SAF

	MODEL NUMBER	DESCRIPTION	NET WT. (POUNDS)
DOCK LOADING LIGHT OPTIONS	PAR-38-90	90 WATT HALOGEN BULB, 1270 LUMENS (LL)	1
	LL-S-BULB	SODIUM BULB - 50 WATT	2
	LL-FL-BULB	FLUORESCENT BULB - 55 WATT	2
	LL-S-HEAD	SODIUM HEAD ONLY	2
	LL-WG	WIRE GUARD - 6" DIAMETER (INCANDESCENT)	2
	LL-GRILL	GRILL / DIFFUSER (SODIUM)	5
	LL-STAND	LIGHT STAND, 83" HIGH, INCLUDES ADJUSTABLE BRACKET	60
	LLF-18	18" FAN, MOUNTING BRACKETS AND POWER CORD	20
	LL-40-FAN	PACKAGE: LL-40 LIGHT, FAN, BRACKETS AND WIRING	37



HIGH PRESSURE SODIUM
model LLS-40

Halogen Work Lights 115V 1-PHASE STANDARD

Superior lighting at the job-site assures worker safety plus accurate loading and unloading. These premium lights are UL listed and CSA certified. 500 watt halogen bulb included providing 11,000 lumens. Model HLGN-PWL is adjustable in height from 40" to 60½".



MODEL NUMBER	DESCRIPTION	MOUNTING STYLE	LIGHT BULBS	NET WT. (LBS.)
HLGN-FWL	SINGLE LAMP	FLOOR	500 WATT	5
HLGN-PWL	DOUBLE HEAD / DOUBLE CLAMP	PEDESTAL	500 WATT	12

model
HLGN-PWL



model
HLGN-FWL





Easy to use ratchet mechanism allows one person to adjust and ratchet into place.

Cargo Bars

- Keep trailer contents in place - eliminate damaged goods
- Simple mechanical lock - will not vibrate loose

During transport, keep trailer contents securely in place with these easy to use Cargo Bars. Constructed of 1½" square tubing, unless specified. 14 gauge wall construction is lightweight, yet extremely strong. Square articulating steel end plates feature rubber pads for positive gripping action. End plates measure 4" x 4" on models CL-15, CL-16, CL-17, CL-18, and CBH-32. End plates measure 4" x 2¾" on model CB-7, CB-7-R, and CB-7-S. Bars fit between trailer walls.

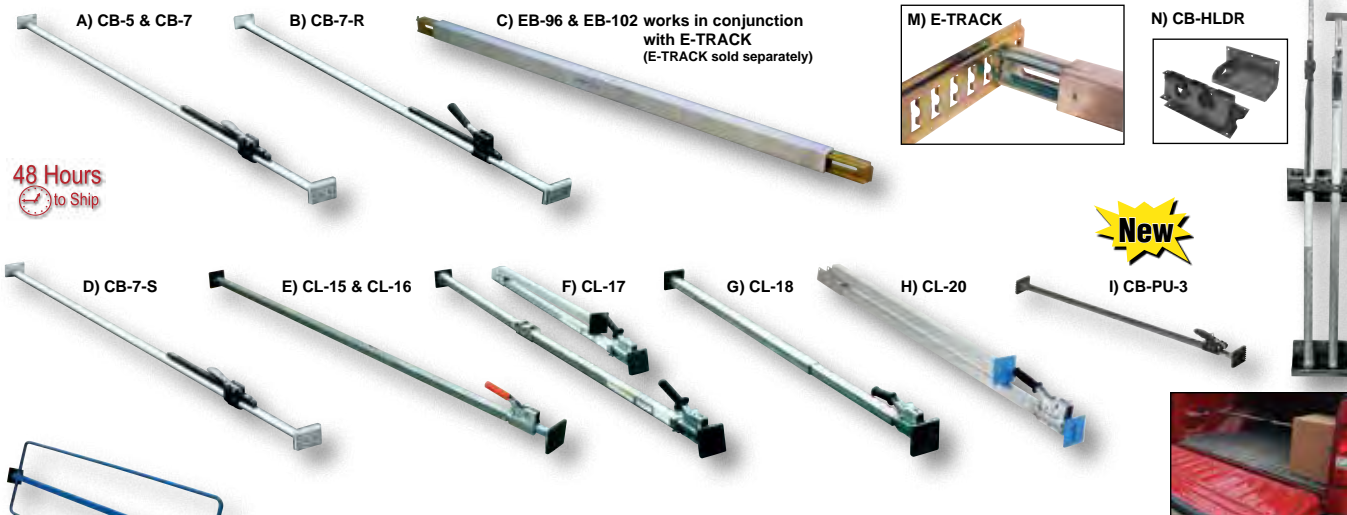

48 Hours
to Ship

New

J) CBH-32
Top Hoop 70"W x 9"H
Bottom Hoop 78"W x 9"H



K & L) Cargo Bar Hoops
model CH-7 for CB series Cargo Bars
model CH-3 for CL series Cargo Bars
(cargo bars sold separately, hoops
sold in pairs)

TYPE	MODEL NUMBER	DESCRIPTION	SERVICE RANGE	NET WT. (LBS.)
A	CB-5	ONE PIECE ALUMINUM (ROUND TUBE)	88" to 103"	8
A	CB-7	ONE PIECE ALUMINUM Heavy-Duty (ROUND TUBE)	89" to 104"	9
B	CB-7-R	ONE PIECE ALUMINUM RATCHET (ROUND TUBE)	89" to 103"	10
C	EB-96	ONE PIECE ALUMINUM (E-TRACK)	85" to 96"	19
C	EB-102	ONE PIECE ALUMINUM (E-TRACK)	92" to 102"	21
D	CB-7-S	ONE PIECE STEEL (ROUND TUBE)	88½" to 103"	12
E	CL-15	ONE PIECE STEEL	87" to 119"	15
E	CL-16	ONE PIECE STEEL GALVANIZED	87" to 119"	15
F	CL-17	TWO PIECE STEEL GALVANIZED (FOLDING)	88" to 116"	22
G	CL-18	TWO PIECE STEEL GALVANIZED (TELESCOPIC)	90" to 139"	24
H	CL-20	TWO PIECE STEEL E & A TRACK (FOLDING)	87" to 116"	18
I	CB-PU-3	ONE PIECE STEEL TRUCKS/VANS (ROUND TUBE)	40" to 70"	5
J	CBH-32	ONE PIECE STEEL WITH FULL HOOPS	87" to 116"	28
K	CH-7	GALVANIZED HOOPS (FOR CB SERIES ONLY)	30½"W x 23⅛"H	16
L	CH-3	GALVANIZED HOOPS (FOR CL SERIES ONLY)	31"W x 24½"H	19
M	E-TRACK	STEEL SECTION OF E-TRACK FOR TRAILERS	10 FOOT	16
N	CB-HLDR	CARGO BAR HOLDER	--	7

Truck Mounted Strap Winches

48 Hours
to Ship

Tighten down loads to eliminate shifting. Choose from either weld or bolt on design. Strap and chrome plated winch bar sold separately. Low profile design available. Accommodates 4" straps up to 30' long.



30 FOOT STRAP
model STRAP-30

MODEL NUMBER	DESCRIPTION	OVERALL SIZE (W x L x H)	NET WT. (POUNDS)
SW-4-PSW	WELD ON WINCH	3½" x 7¾" x 6¼"	10
SW-4-PSB	BOLT ON WINCH	3½" x 7¾" x 6¼"	11
SW-BAR	MULTI-TASK WINCH BAR	1¾" DIA. x 34½"L	7
SW-BAR-PT	PAINTED WINCH BAR	1¾" DIA. x 34½"L	8
STRAP-30	30 FOOT STRAP	4" W x 30'L	7

Cargo Strapping & Guards

Guard against damages from slipping and shifting loads while transporting products. Spring loaded e-track fittings provide quick one-handed connection to anchor point. Both ratchet and cam buckle models tighten and release quickly. Edge Guards are reusable, durable, and economical. Tough strapping fabric is made of a polyester webbing. Model TARP-C promotes the life of your tarps and protect sharp product corners.



MODEL NUMBER	STRAP WIDTH	WORKING LENGTH	UNIFORM WORKING LOAD	TIGHTENING MECHANISM	FASTENER	NET WT. (LBS.)
STRAP-12-RE	2"	12'	1,000 lbs.	RATCHETING	E-CLIP	2
STRAP-16-CE	2"	16'	1,200 lbs.	CAM	E-CLIP	4
STRAP-16-RE	2"	16'	1,200 lbs.	RATCHETING	E-CLIP	3
STRAP-27-RH	2"	27'	3,325 lbs.	RATCHETING	ROD HOOK	6
STRAP-27-FH	2"	27'	3,325 lbs.	RATCHETING	FLAT HOOK	6
STRAP-6-RTO	2"	6"	800 lbs.	D-RING/STRAP	E-CLIP	2
STRAP-15-RTB	1"	15'	1,500 lbs.	RETRACTABLE	HOOKS	2
STRAP-6-RTB	1"	6"	1,500 lbs.	RETRACTABLE	HOOKS	2
ROPE-8-TD	1/4"	8'	150 lbs.	TIE-DOWN	HOOKS	2
E-CLIP-W	BEAM E-SOCKET SUPPORTS THE END OF WOOD 2 x 4					2
E-CLIP-D	TIE OFF THE "D" RING WHEN ATTACHED TO THE E-TRACK					2
EDGE-R12	RUBBER EDGE GUARDS, 5 3/4"W x 12"L, 50 PIECES PER PACKAGE					37
EDGE-R6	RUBBER EDGE GUARDS, 4 3/4"W x 6"L, 100 PIECES PER PACKAGE					31
EDGE-S7	STEEL EDGE GUARDS, 7 1/2"W x 4 7/8"L, 10 PIECES PER PACKAGE					15
TARP-C	RECYCLE MOLDED PLASTIC, 6 7/8"W x 5 1/2"L, 16 PIECES PER PKG.					3



Lockable Load Binders

- Provides 5,400 lbs. working load limit
- Ideal for trailers, campers, or farmers

Used for chain binding applications in trucking and marine industries. Heavy-duty, forged steel construction. Uniform proof capacity is 10,000 pounds. Ultimate uniform capacity is 19,000 pounds. Accommodates 5/16" to 3/8" chain. Insert lock through hole for maximum theft protection.

MODEL NUMBER	DESCRIPTION	TAKE UP	NET WT. (LBS.)
LBDR-9-L	LEVER	3 3/4"	15
LBDR-13-L	RATCHET	3"	12



Pallet Cargo Decker

Reduce freight damage while protecting delicate cargo with our Pallet Cargo Decker. Fits into standard semi-trailers and allows an increase in trailer load volume where wasted space once was. Holds boxes, pallets, and other freight. 5,000 lb. uniform capacity. Wood platform not included.

MODEL NUMBER	DESCRIPTION	OVERALL SIZE (W x H x D)	NET WT. (LBS.)
PCD-92	SINGLE	90 1/4" x 56" x 49 1/2"	144
PCD-92D	DOUBLE DECKER	90 1/4" x 56" x 49 1/2"	228
PCD-92DS	DOUBLE WITH SIDES	90 1/4" x 56" x 49 1/2"	253
PCD-92DSB	DOUBLE W/SIDES & BACK	90 1/4" x 56" x 49 1/2"	287
PCD-STL	OPTIONAL 10 GAUGE STEEL PLATFORM		150

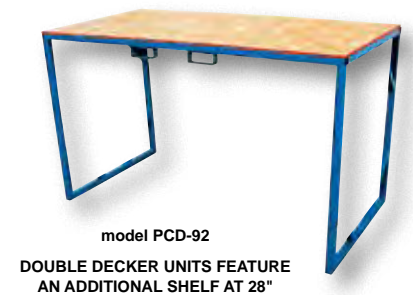

Reusable Dunnage Bags

Minimize product shifting and damage in transit. The 2-ply construction consists of a polypropylene weave outer bag protecting a polyethylene inner bag. The bag provides 6 psi pressure seal. Stores flat when empty. Fill with standard shop air.

Air Bag Inflation Valve tool offers easy grip for convenient use. Press and hold red vinyl coated lever. The cast zinc body has a chrome plated finish. Air inlet thread female 1/4" NPT.

MODEL NUMBER	DESCRIPTION	SIZE (W x H)	NET WT. (LBS.)
BAG-4836	REUSABLE BAG	48" x 36"	2
BAG-4884	REUSABLE BAG	48" x 84"	2
BAG-I	AIR BAG INFLATION VALVE		1





GENERAL DUTY
QPC-7280-DP



ALL WEATHER
QPC-7280-UP

48 Hours
to Ship



HEAVY DUTY
QPC-7280-VP



model PWC-G

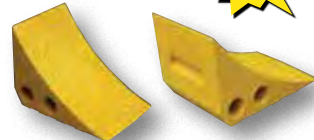

model PWC-Y

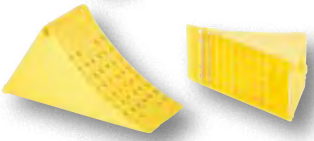

model PLWC-Y



A) LWC-15



B) LWC-14



C) LWC-14M

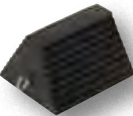

D) RWC-8

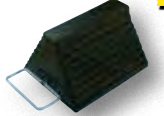

E) RWC-8-HDL

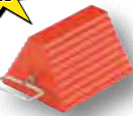

F) ORWC-8-HDL

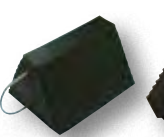

G) RWC-9-U



SERRATED
BOTTOM

H) RWC-8-SBS



I) RWC-25

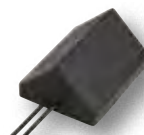

J) RWC-10-HDL



K) RWC-5

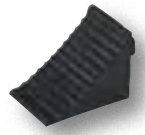

L) RWC-11

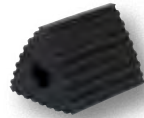

M) RMC-4

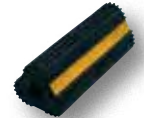

N) EX-4



O) EX-11



P) EX-13

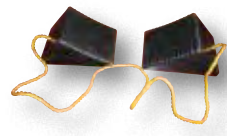

Q) RWC-2-PR

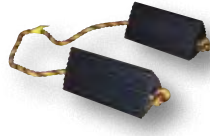

R) AC-13

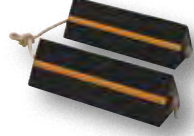

S) AC-18

Quilted Moving Pads

Cushion and protect furniture, machinery, and electronic equipment. Each pad measures 72" wide by 80" long. Model QPC-7280-UP is water and mildew resistant. Units are sold in quantities of 12 and the weights below reflect a dozen units.

MODEL NUMBER	DESCRIPTION	NET WEIGHT (POUNDS)
QPC-7280-DP	GENERAL DUTY (both sides cotton)	57
QPC-7280-UP	ALL WEATHER (both sides polyester)	63
QPC-7280-VP	HEAVY-DUTY (one side polyester/other side cotton)	82

Plastic Wheel Chocks

These plastic wheel chocks are durable yet light enough to take along when you travel. Series *PWC*, is made of 100% recycled plastic. Resistant to damage from sunlight, oil, salt, and chemicals. Features a molded-in handle.

Model *PLWC-Y*, features a molded-in handle. Bottom surface includes three (3) steel cleats for extra traction.

MODEL NUMBER	DESCRIPTION	DIMENSIONS (W x H x D)	COLOR	NET WT. (LBS.)
PWC-G	RECYCLED PLASTIC	7½" x 7½" x 10¼"	GREEN	7
PWC-Y	RECYCLED PLASTIC	7½" x 7½" x 10¼"	YELLOW	6
PLWC-Y	MOLDED PLASTIC	7¼" x 9" x 18½"	YELLOW	6

Rubber Wheel Chocks

Constructed of reinforced rubber to provide a sure grip on virtually any surface. Curved surface contours to fit tires. Rubber resists tearing, abrasion, ozone weathering, etc. Functional design is durable in all weather conditions. Series *RWC-8* is constructed of a mix of virgin and recycled, no reinforcement cords.

The Airline Chocks are suitable for small and large aircraft. Model *AC-13* includes a 36" long polypropylene rope, while model *AC-18* has a 14" long polypropylene rope between the chocks.

TYPE	MODEL NUMBER	DESCRIPTION	DIMENSIONS (W x H x D)	NET WT. (LBS.)
A	LWC-15	LAMINATED RUBBER	8" x 8" x 8"	13
B	LWC-14	LAMINATED RUBBER	10" x 5½" x 10"	17
C	LWC-14M	LAMINATED RUBBER (RUBBER GRIPS)	10" x 5½" x 10"	19
D	RWC-8	MOLDED RUBBER (EYEBOLT)	9¼" x 6" x 8"	11
E	RWC-8-HDL	MOLDED RUBBER (HANDLE)	9¼" x 6" x 8"	12
F	ORWC-8-HDL	MOLDED RUBBER (ORANGE)	9¼" x 6" x 8"	11
G	RWC-9-U	MOLDED RUBBER (U HANDLE)	9¼" x 6" x 8"	11
H	RWC-8-SBS	MOLDED RUBBER (SERRATED BOTTOM)	9¼" x 6" x 8"	10
I	RWC-25	MOLDED RUBBER (JUMBO)	16" x 8" x 12"	25
J	RWC-10-HDL	MOLDED RUBBER (POSITIONING HANDL)	8" x 5" x 10"	12
K	RWC-5	MOLDED RUBBER (MOLDED HANDLE)	6" x 4" x 8"	5
L	RWC-11	MOLDED RUBBER (WHC-MR)	7" x 7¼" x 10"	11
M	RMC-4	EXTRUDED RUBBER	6½" x 4¾" x 4¼"	5
N	EX-4	EXTRUDED RUBBER	10" x 3¾" x 4½"	5
O	EX-11	EXTRUDED RUBBER	8½" x 6" x 8½"	14
P	EX-13	EXTRUDED RUBBER	12" x 5¾" x 6½"	18
Q	RWC-2-PR	RUBBER W/ROPE CONNECTED	5" x 4" x 8"	10
R	AC-13	AIRLINE CHOCK WITH ROPE	10" x 4½" x 5"	12
S	AC-18	AIRLINE CHOCK WITH ROPE	18" x 5½" x 6"	36

48 Hours
to Ship



Aluminum Wheel Chocks

Extruded lightweight aluminum that is easy to handle. Features a serrated top to grip the tire and a triple edged bottom to grip the ground. Optional handle and sign attachment available.

TYPE	MODEL NUMBER	DESCRIPTION	OVERALL SIZE (W x H x D)	NET WT. (LBS.)
A	EALUM-7	CHOCK	7" x 8" x 11 ⁵ / ₈ "	8
B	EALUM-7-HNDG	CHOCK WITH HAND GRIP	10" x 8" x 11"	7
C	EALUM-YEL	YELLOW CHOCK	7" x 8" x 11 ⁵ / ₈ "	8
D	EALUM-7-H	CHOCK WITH HANDLE	17 ³ / ₈ " x 37 ¹ / ₂ " x 12"	13
E	EALUM-7-HS	CHOCK W/HANDLE & SIGN	22 ¹ / ₂ " x 36 ¹ / ₂ " x 13"	13
F	CWS-13	ALUMINUM CHOCK W/FLAG	14" x 39 ¹ / ₄ " x 10 ¹ / ₂ "	16



Steel Wheel Chocks

- G) Textured tread plate to provide maximum traction.
- H) Open face radius allows chock to be used with any size tire. Includes 10 ft. chain.
- I) Formed chock utilizes a saw tooth bottom for traction.
- J) Features grip slot for easy pick up and positioning.
- K) Slope design contours to truck wheel.
- L) Rugged all welded construction. Works in mud, sand, or concrete.
- M) Serrated steel wheel chock, grate style, 11¹/₄" D including handle, galvanized finish, includes positioning handle with grip.

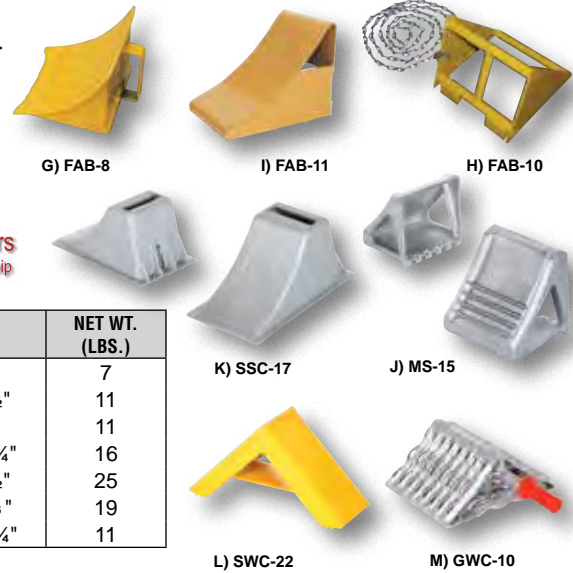

TYPE	MODEL NUMBER	DESCRIPTION	DIMENSIONS (W x H x D)	NET WT. (LBS.)
G	FAB-8	WELDED STEEL CHOCK	7 ¹ / ₂ " x 8" x 8"	7
H	FAB-10	FABRICATED STEEL CHOCK	9 ³ / ₄ " x 7 ¹ / ₂ " x 10 ¹ / ₂ "	11
I	FAB-11	FORMED STEEL CHOCK	8" x 9" x 11"	11
J	MS-15	MOLDED CAST STEEL CHOCK	8 ⁹ / ₁₆ " x 7 ³ / ₁₆ " x 8 ¹ / ₄ "	16
K	SSC-17	CAST STEEL SLOPE CHOCK	8 ³ / ₄ " x 8 ¹ / ₂ " x 15 ¹ / ₂ "	25
L	SWC-22	STEEL WHEEL CHOCK	6" x 9 ⁹ / ₁₆ " x 17 ⁵ / ₁₆ "	19
M	GWC-10	SERRATED STEEL CHOCK	15 ⁷ / ₈ " x 4 ⁷ / ₈ " x 11 ¹ / ₄ "	11

*14" DEEP INCLUDING HANDLE

Urethane Wheel Chocks

Bright orange for greater visibility. Incoming and outgoing drivers can easily see chock for added safety. Tread on chock face provides better grip and reduces slippage.

MODEL NUMBER	DESCRIPTION	DIMENSIONS (W x H x D)	NET WT. (LBS.)
URWC-2	MINI-URETHANE CHOCK	7" x 6" x 8"	3
URWC-8	URETHANE CHOCK	9 ¹ / ₂ " x 8" x 6"	3
URWC-8-HDL	URETHANE WITH HANDLE	9 ¹ / ₂ " x 8" x 6"	4
URWC-15	URETHANE WHEEL CHOCK	8" x 8" x 11"	5
URWC-25	JUMBO URETHANE CHOCK	14 ¹ / ₂ " x 14 ¹ / ₂ " x 17"	21
URWC-25-SS	JUMBO CHOCK W/STEEL STUDS	14 ¹ / ₂ " x 14 ¹ / ₂ " x 17"	22
URWC-45	MEGA URETHANE CHOCK	18" x 18" x 24"	32

*MOLDED HOLE THROUGH WIDTH OF CHOCK FOR ATTACHING CHAIN (not included)

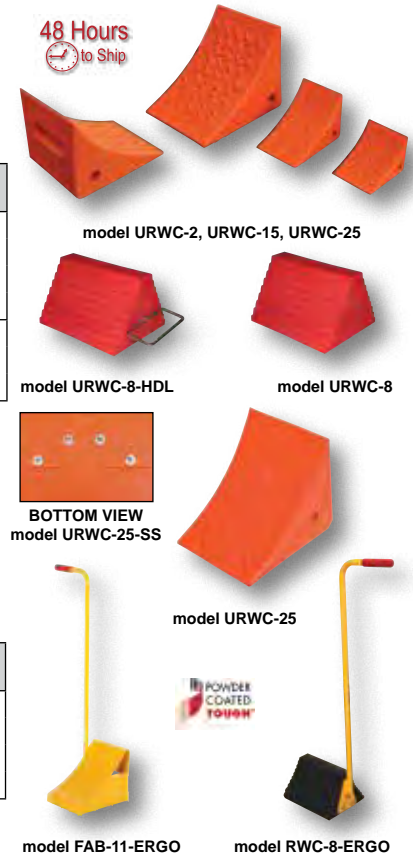

Ergo-Handle Wheel Chocks

Ergonomically designed to make it easy to move wheel chocks in and out of position under trailer wheels. Reduce the risk of back, knee, and foot injuries. Handle is constructed of steel and includes a yellow powder coat finish. Factory installed only.

MODEL NUMBER	TYPE OF WHEEL CHOCK	WHEEL CHOCK (W x H x D)	NET WT. (LBS.)
RWC-8-ERGO	MOLDED RUBBER	9 ¹ / ₄ " x 37" x 8"	16
ORWC-8-ERGO	MOLDED RUBBER	7 ³ / ₄ " x 5 ⁵ / ₈ " x 12 ¹ / ₈ "	11
FAB-10-ERGO	FABRICATED STEEL	10 ¹ / ₂ " x 10" x 10 ¹ / ₂ "	17
FAB-11-ERGO	FABRICATED STEEL	8" x 9" x 11 ³ / ₄ "	13

model FAB-11-ERGO model RWC-8-ERGO

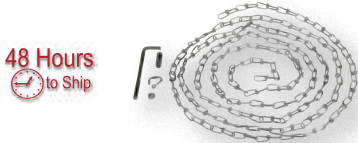

48 Hours
to Ship

CHAIN & HANGER
model OH-15

Wheel Chock Accessories

Chain and Hangers - Discourage theft and misplacement of wheel chocks. Facilitate safety in the dock area. 15 foot chain attaches to the hanger. Hanger is then secured to the dock wall. Chain is fastened to the chock with cold shut.

Straps - Bright red / yellow in color for ease to see. Strap end includes large loop for easy pulling and carrying. Easily attach to chock using small choker loop. Longer 15' strap includes second loop for attachment of second wheel chock. Both chocks can be removed from the same side of the trailer.

Wheel Chock Holder - Keep wheel chocks safe and prepared for use at any moment. The holder features steel construction for long life and durability, yellow powder coat finish for visibility and predrilled mounting holes for easy attachment. Holds up to 40 pounds in a usable width of 10¾". Overall size is 12-7/8"W x 7-7/16"D x 6-7/16"H.

Wheel Chock Warning Signs - Warn truck drivers and dock workers to chock their wheels as required by law. Weather resistant. Bright red lettering provides high visibility. Sign has four (4) mounting holes. Reflective sign is available for docks open at dawn and dusk. Signs and Vinyl Sticker measure 11¾"W x 9¾"H.



WHEEL CHOCK HOLDER
model WC-H



WARNING SIGN
model SA-1012



NYLON STRAP
model STRAP-3-WC

MODEL NUMBER	DESCRIPTION	NET WT. (LBS.)
OH-15	#2 DOUBLE LOOP COIL CHAIN WITH HANGER	3
OH-15R	#2 CHAIN & HANGER WITH REFLECTOR	4
OH-HD	HD PROOF COIL CHAIN (3/16" THICK) W/HANGER	7
OH-15-STRAP	15 FOOT NYLON STRAP & HANGER KIT	3
STRAP-3-WC	3 FOOT NYLON STRAP	2
STRAP-15-WC	15 FOOT NYLON STRAP	4
WC-H	WHEEL CHOCK HOLDER	3
SA-1012	ALUMINUM WHEEL CHOCK SIGN	1
SF-1012	REFLECTIVE ALUMINUM WHEEL CHOCK SIGN	1
SV-1012	VINYL WHEEL CHOCK STICKER	2

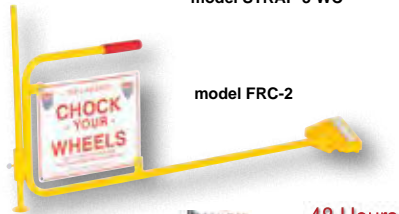

model FRC-2



model SRC-1

model SRC/SRC



model SRC/FRC

Universal Steel Rail Chocks

The Single Steel Rail Chock fits most standard size rails. The powder coated steel construction is designed to sustain longevity through use in a variety of harsh environments. The double sided flanges keep chocks on track and the hardened steel spurs that are located on the bottom side of the chock, are used to maximize a positive grip.

Model SRC/SRC features a 30" long chain which connects the combo sets together for added security. Handle length is 10".

Model FRC-2 & SRC/FRC has a handle projection of 36". Handle height is 14". The adjustable support legs are used to balance the Flag Rail Chocks. Chain length is 30" on combo units. The Aluminum "Chock Your Wheels" sign is visible from both sides. Steel construction.

MODEL NUMBER	DESCRIPTION	NET WT. (LBS.)
FRC-2	FLAG RAIL CHOCK W/ADJUSTABLE HEIGHT LEG	15
SRC-1	SINGLE RAIL CHOCK	8
SRC/FRC	SINGLE RAIL CHOCK / FLAG RAIL CHOCK COMBO	23
SRC/SRC	SINGLE RAIL CHOCK / SINGLE RAIL CHOCK COMBO	16

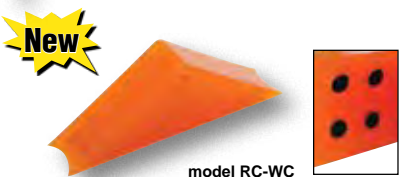

model RC-WC

Magnetic Rail Car Wheel Chock

The Magnetic Rail Car Wheel Chock is designed to stabilize railcar wheels while loading and unloading. Standard features include; rail track attaching magnets for extra grip, pick up holes for easy transportation, a nylon material design for durability and longevity, and orange color for safety. Model RC-WC-HOOK allows you to pick up the Rail Chock without bending over.

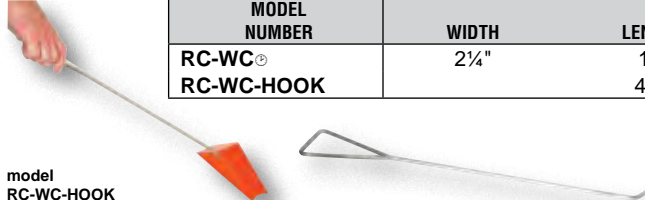

model RC-WC-HOOK

MODEL NUMBER	WIDTH	LENGTH	HEIGHT	NET WEIGHT (POUNDS)
RC-WC	2¼"	11"	3⅝"	3
RC-WC-HOOK		4¾"	30"	2

Industrial Rubber Wedges

Excellent for safety when stacking cylindrical objects. These extruded rubber wedges offer several advantages over wooden blocks or other forms of wedges: its resilience avoids creasing or wrinkling paper as well as scratching or marring surfaces; it increases its grip as weight is increased.

MODEL NUMBER	WIDTH	DEPTH	HEIGHT	NET WEIGHT (POUNDS)
RBW-2 [Ⓢ]	4"	6½"	3"	2
RBW-3 [Ⓢ]	6"	6½"	3"	5
RBW-5 [Ⓢ]	12"	6¾"	3"	7
RBW-10 [Ⓢ]	24"	6¾"	3"	12



Mechanical Screw Jacks

Acme thread post supports load. No seals to leak. Will not drift down even after an extended period of time.

MODEL NUMBER	UNIFORM CAPACITY (TONS)	LOWERED HEIGHT	RAISED HEIGHT	TRAVEL (INCHES)	NET WT. (LBS.)
MSJ-3 [Ⓢ]	3	8¾"	13"	4¼"	12
MSJ-5 [Ⓢ]	5	9¾"	15"	5¼"	18
MSJ-10 [Ⓢ]	10	11"	17"	6"	20
MSJ-20 [Ⓢ]	20	12¾"	20"	7¼"	29



Heavy Duty Farm Jacks

Designed to lift, pull, push, and move heavy machinery and heavy objects. Ideal for lifting tractor and 4-wheel drive vehicles, tensioning wire fences, and pulling/pushing or removing posts, poles, tree stumps, etc. Hydraulic free, full lever mechanical operation. Solid cast iron construction. Heavy duty 33" ratchet operating lever provides maximum leverage.

MODEL NUMBER	UNIFORM CAPACITY (TONS)	LOWERED HEIGHT	RAISED HEIGHT	TRAVEL (INCHES)	NET WT. (LBS.)
HDFJ-48 [Ⓢ]	3.5	6"	42"	36"	31
HDFJ-60 [Ⓢ]	3.5	6"	53"	47"	36



Trailer Jacks

The Trailer Jack adjustable lift range provides easy hitching and unhitching of a loaded trailer. Use for a wide variety of lifting, leveling, and adjustment applications. Ideal for industrial, utility, construction, or agricultural equipment trailers. Heavy-duty construction. Available with a side or top crank position. Mounting bracket attaches in a variety of ways in order to meet your application needs. Scissor jacks provide stability and leveling to unattached trailers and equipment.

TYPE	MODEL NUMBER	MOUNT	CRANK POSITION	UNIFORM CAPACITY	LIFT RANGE	NET WT. (LBS.)
A	TJ-06 [Ⓢ]	SIDE SWIVEL/WHEEL	SIDE	1,000	10"	15
B	TJ-F3 [Ⓢ]	TUBE RING	TOP	2,000	15"	15
C	TJ-F1 [Ⓢ]	TUBE RING	TOP	1,000	10"	13
D	TJ-F2 [Ⓢ]	FLANGE	TOP	1,000	10"	17
E	TJ-F4 [Ⓢ]	FLANGE	TOP	2,000	15"	19
F	TJ-AF [Ⓢ]	A-FRAME	TOP	2,000	10"	14
G	FJ-K1 [Ⓢ]	A-FRAME	SIDE	1,000	15"	13
H	FJ-K2 [Ⓢ]	A-FRAME	SIDE	2,000	15"	14
--	CT-02	CRANK JACK	TOP	2,000	14"	9
--	CT-05	CRANK JACK	TOP	5,000	14"	12
I	NJ-BP [Ⓢ]	NOSE JACK BASE PAD	--	--	--	3
J	NJ-CR [Ⓢ]	NOSE JACK CASTER	--	--	--	2
K	SJ-7523	SCISSOR JACK		7,500	23"	17
K	SJ-7529	SCISSOR JACK		7,500	29"	19
-	SJ-HDL	OPTIONAL HANDLE FOR SJ-7523 & SJ-7529				1



48 Hours
to Ship



Trailer Stabilizing Jacks

Jacks are used to prevent up-ending of semi-trailers when they are not connected to a tractor during loading and unloading operations. Also used to level trailers parked on sloped ground and to prevent landing gear from sinking into a soft surface. High strength steel construction. Flush-type zerk fitting for lubricating ACME screw. Meets OSHA regulations when used with wheel chocks. Powder coat safety yellow finish. Includes reflective collar for visibility at night.



model SJS-1012

model SAJ-1012

TYPE	MODEL NUMBER	DESCRIPTION	UNIFORM STATIC CAPACITY (LBS.)	UNIFORM LIFTING CAPACITY (LBS.)	SERVICE RANGE	WHEEL SIZE & TYPE	NET WT. (LBS.)
A	BFSJ-2748	BIG FOOT JACK	100,000	40,000	40" to 51"	10" hard rubber	162
B	LO-J-BEAM	RATCHET BEAM	100,000	40,000	40" to 51"	10" x 2" hard rubber	182
C	SP-TOP-BEAM	SPIN TOP BEAM	100,000	40,000	40" to 51"	10" x 2" hard rubber	200
D	H-LO-J-BEAM	HYDRAULIC BEAM	100,000	40,000	41" to 47"	10" x 2" hard rubber	175
E	CJ-BEAM-SN	HAND CRANK	100,000	50,000	41" to 55"	16" solid foam	238
E	CJ-BEAM-PN	HAND CRANK	100,000	50,000	41" to 55"	16" fully pneumatic	221
F	SJ-40	ECONOMY (flat base)	50,000	5,000	44" to 51"	N/A	44/UPS
G	LO-J	RATCHET	100,000	40,000	39" to 51"	10" hard rubber	137
H	HI-J	RATCHET	100,000	40,000	45" to 57"	10" hard rubber	141
I	SP-TOP	SPIN TOP	100,000	40,000	39½" to 51"	10" hard rubber	129
J	SP-TOP-R	RATCHET	100,000	40,000	39½" to 51"	10" hard rubber	138
K	SJ-35	ECONOMY (rounded base)	50,000	5,000	44" to 51"	N/A	39/UPS
L	SJ-35-2H	ECONOMY	50,000	5,000	44" to 51"	N/A	39/UPS
M	SJ-35-EF	ECONOMY	50,000	5,000	41" to 57½"	8" hard rubber	102
TRAILER STABILIZING JACK OPTIONS							
JACK-100		50,000 POUNDS LIFTING CAPACITY (NOT AVAILABLE ON SJ series)					18
SJS-1012		ALUMINUM STABILIZING JACK TRAILER INSTRUCTION SIGN					1
SAJ-1012		ALUMINUM DRIVERS BEWARE INSTRUCTION SIGN					1

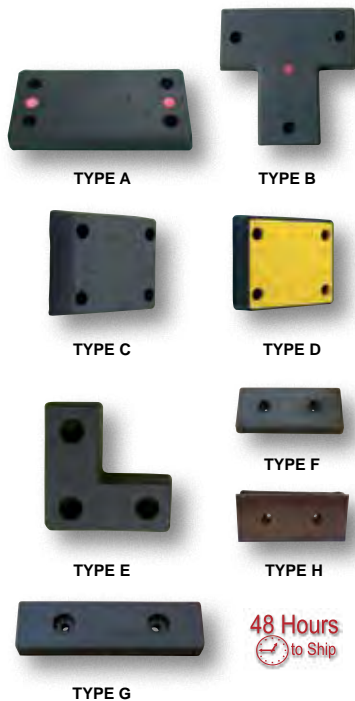

Specialty Molded Dock Bumpers

Manufactured from fiber reinforced prime rubber containing nylon and polyester. These molded bumpers are built to endure years of abusive pounding. All units have pre-drilled countersunk mounting holes for easy installation. Plastic face bumper, model B-1213-4PF, features two (2) piece construction fully assembled and ready for installation.

TYPE	MODEL NUMBER	OVERALL SIZE (W x H x P)	# OF HOLES & SIZE	NET WT. (LBS.)
A	B-1224-3	24"W x 12"H x 3"P	4, 3/4"	34
A	B-1224-6	24"W x 12"H x 6"P	4, 3/4"	57
B	T-22	22"W x 22"H x 3"P	3, 3/4"	44
C	B-1213-4	12"W x 13"H x 4"P	4, 3/4"	24
D	B-1213-4PF	12"W x 13"H x 4"P	4, 3/4"	24
--	RF	REPLACEMENT FACE (FOR B-1213-4PF ONLY)		1
E	L-1818-4	18"W x 18"H x 4"P	3, 13/16"	36
F	B-516	16"W x 5"H x 2"P	2, 5/8"	8
G	B-818	18"W x 8"H x 2"P	2, 5/8"	16
H	B-516-SF	16"W x 5"H x 2"P STEEL FACED MOLDED BUMPER	2, 3/4"	15
--	B-818-SF	18"W x 8"H x 2"P STEEL FACED MOLDED BUMPER	2, 3/4"	35
ANCHOR BOLTS HARDWARE FOR CONCRETE INSTALLATION				
---	AS-346	(1) 3/4" x 6¼"		1
---	AS-346-4PK	(4) 3/4" x 6¼"		4
---	AS-584	(1) 5/8" x 4"		1
---	AS-584-4PK	(4) 5/8" x 4"		4

Laminated Dock Bumpers

Laminated style dock bumpers provide durable, economical protection for your loading dock and trailers. Units are constructed of fabric reinforced rubber from recycled truck tires. Pads are laminated between painted structural angles and held together with 3/4" steel tie rods. Installation is quick and easy by bolting or welding units to the dock. *Width is bolt hole center to bolt hole center.* Bolt holes are 13/16" diameter. Contact factory for other sizes.

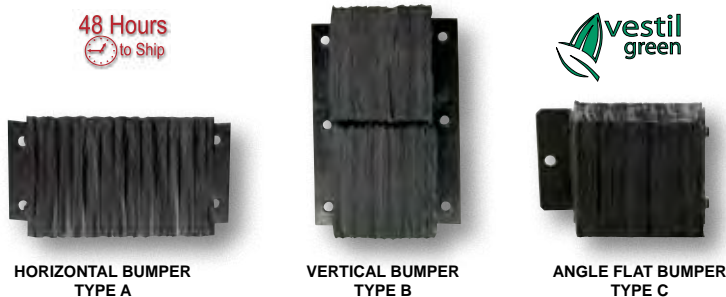

4.5" PROJECTION LAMINATED DOCK BUMPERS				
TYPE	MODEL NUMBER	DIMENSIONS (H x W x P)	NO. OF HOLES	NET WT. (LBS.)
A	1012-4.5	10" x 12" x 4 1/2"	4	22
A	1014-4.5	10" x 14" x 4 1/2"	4	25
A	1018-4.5	10" x 18" x 4 1/2"	4	36
A	1024-4.5	10" x 24" x 4 1/2"	4	45
A	1030-4.5	10" x 30" x 4 1/2"	4	60
A	1036-4.5	10" x 36" x 4 1/2"	4	68
A	1096-4.5*	10" x 96" x 4 1/2"	4	191
A	1212-4.5	12" x 12" x 4 1/2"	4	24
A	1214-4.5	12" x 14" x 4 1/2"	4	31
A	1218-4.5	12" x 18" x 4 1/2"	4	41
A	1224-4.5	12" x 24" x 4 1/2"	4	56
A	1230-4.5	12" x 30" x 4 1/2"	4	69
A	1236-4.5	12" x 36" x 4 1/2"	4	88
A	1296-4.5*	12" x 96" x 4 1/2"	4	215
A	624-4.5	6" x 24" x 4 1/2"	4	26
A	636-4.5	6" x 36" x 4 1/2"	4	45
C	1014-4.5F	10" x 14" x 4 1/2"	2	32
C	1214-4.5F	12" x 14" x 4 1/2"	2	32
B	V-1120-4.5	20" x 11" x 4 1/2"	6	39
B	V-1124-4.5	24" x 11" x 4 1/2"	6	40
B	V-1130-4.5*	30" x 11" x 4 1/2"	8	92
B	V-1136-4.5*	36" x 11" x 4 1/2"	8	123

*DIMENSIONS REFLECT RUBBER PORTION ONLY

6" PROJECTION LAMINATED DOCK BUMPERS				
TYPE	MODEL NUMBER	DIMENSIONS (H x W x P)	NO. OF HOLES	NET WT. (LBS.)
A	1012-6	10" x 12" x 6"	4	24
A	1014-6	10" x 14" x 6"	4	34
A	1018-6	10" x 18" x 6"	4	43
A	1024-6	10" x 24" x 6"	4	58
A	1030-6	10" x 30" x 6"	4	64
A	1036-6	10" x 36" x 6"	4	89
A	1212-6	12" x 12" x 6"	4	31
A	1214-6	12" x 14" x 6"	4	39
A	1218-6	12" x 18" x 6"	4	51
A	1224-6	12" x 24" x 6"	4	67
A	1230-6	12" x 30" x 6"	4	73
A	1236-6	12" x 36" x 6"	4	94
A	1296-6*	12" x 96" x 6"	4	316
B	V-1120-6	20" x 11" x 6"	6	50
B	V-1124-6	24" x 11" x 6"	6	61
B	V-1130-6*	30" x 11" x 6"	8	76
B	V-1136-6*	36" x 11" x 6"	8	134

*DIMENSIONS REFLECT RUBBER PORTION ONLY

ANCHOR BOLTS HARDWARE FOR CONCRETE INSTALLATION		
MODEL NUMBER	QUANTITY AND SIZE	NET WT. (LBS.)
AS-344	(1) 3/4" x 4 1/4"	1
AS-344-4PK	(4) 3/4" x 4 1/4"	4

DC-25

Extruded Bumpers

Made of all weather and abrasion resistant rubber. The half-oval shape allows for effective fendering action over a wide radius. A metal plate is located inside 4" and 6" projection bumpers for support while the 2" unit comes with one washer per hole (this does not include the 120" long models). Custom lengths available up to 10 feet. Installation hardware sold separately, see below.

TYPE	MODEL NUMBER	OVERALL SIZE (L x W x H)	# OF HOLES & SIZE	NET WT. (LBS.)
A	M-2-12	12"L x 2"W x 1 3/4"H	2, 3/8"	2
A	M-2-18	18"L x 2"W x 1 3/4"H	2, 3/8"	2
A	M-2-24	24"L x 2"W x 1 3/4"H	2, 3/8"	3
A	M-2-36	36"L x 2"W x 1 3/4"H	3, 3/8"	3
A	M-2-120*	120"L x 2"W x 1 3/4"H	0	13
B	M-4-12	12"L x 4 1/4"W x 4"H	2, 5/8"	8
B	M-4-18	18"L x 4 1/4"W x 4"H	2, 5/8"	10
B	M-4-24	24"L x 4 1/4"W x 4"H	2, 5/8"	14
B	M-4-36	36"L x 4 1/4"W x 4"H	3, 5/8"	18
B	M-4-120*	120"L x 4 1/4"W x 4"H	0	56
C	M-6-12	12"L x 6"W x 6"H	2, 5/8"	14
C	M-6-18	18"L x 6"W x 6"H	2, 5/8"	18
C	M-6-24	24"L x 6"W x 6"H	2, 5/8"	24
C	M-6-36	36"L x 6"W x 6"H	3, 5/8"	34
C	M-6-120*	120"L x 6"W x 6"H	0	137

ANCHOR BOLTS HARDWARE FOR CONCRETE INSTALLATION			
---	MODEL NUMBER	QUANTITY AND SIZE	NET WT. (LBS.)
---	AS-383	(1) 3/8" x 3", USE WITH M-2 SERIES	1
---	AS-383-4PK	(4) 3/8" x 3", USE WITH M-2 SERIES	4
---	AS-584	(1) 5/8" x 4", USE WITH M-4 & M-6 SERIES	1
---	AS-584-4PK	(4) 5/8" x 4", USE WITH M-4 & M-6 SERIES	4

*FOR 120" BUMPERS ADD \$30.00 SKID CHARGE FOR ORDERS UNDER 5 UNITS

48 Hours to Ship



TYPE A • M-2-SERIES



TYPE B • M-4-SERIES

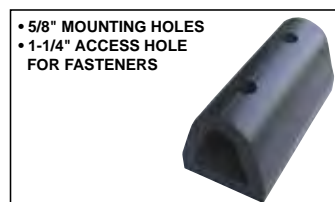

TYPE C • M-6-SERIES

New48 Hours
to Shipmodel
TB-10model
TB-20model
TB-90

model TB-70



model TB-70-Y

Trailer Crane Bumpers

Manufactured from fiber reinforced prime rubber containing nylon and polyester to resist abrasion, impact, wear, and corrosion. Impervious to weather damage. All models have pre-drilled, countersunk mounting holes for easy installation. Installation hardware available separately, see below.

MODEL NUMBER	WIDTH	LENGTH	PROJECTION	COLOR	# OF HOLES & SIZE	NET WT. (LBS.)
TB-10 [Ⓢ]	3"	6"	2 ¹⁵ / ₁₆ "	BLACK	2, 5/8"	3
TB-20 [Ⓢ]	3½"	6"	3½"	BLACK	2, 5/8"	5
TB-70 [Ⓢ]	2"	16"	2"	BLACK	3, 1/2"	3
TB-70-Y [Ⓢ]	2"	16"	2"	YELLOW	3, 1/2"	3
TB-90 [Ⓢ]	5⅝"	7 ⅝"	3¾"	BLACK	4, 5/8"	6
ANCHOR BOLTS HARDWARE FOR CONCRETE INSTALLATION						
AS-125 [Ⓢ]	(1) 1/2" x 5", USE WITH TB-10, TB-20, TB-70, TB-70-Y					1
AS-125-4PK [Ⓢ]	(4) 1/2" x 5", USE WITH TB-10, TB-20, TB-70, TB-70-Y					4
AS-584 [Ⓢ]	(1) 5/8" x 4", USE WITH MODEL TB-90					1
AS-584-4PK [Ⓢ]	(4) 5/8" x 4", USE WITH MODEL TB-90					4

Hardened Molded Bumpers

These pre-drilled bumpers are constructed of fiber reinforced rubber containing nylon and polyester for all weather conditions. Provides high impact resistance. Steel reinforcement rings are molded into each bumper for installation. Uses ¾" anchor bolts. Sold individually. Order installation hardware separately, see below.

48 Hours
to Shipmodel
DBE-10-1model
DBE-30-1

MODEL NUMBER	WIDTH	LENGTH	PROJECTION	# OF HOLES & SIZE	NET WT. (LBS.)
DBE-10-1 [Ⓢ]	4½"	10"	3"	2, 5/8"	6
DBE-20-1 [Ⓢ]	4½"	20"	3"	4, 5/8"	13
DBE-30-1 [Ⓢ]	4½"	30"	3"	5, 1/2"	16
ANCHOR BOLTS HARDWARE FOR CONCRETE INSTALLATION					
AS-584 [Ⓢ]	(1) 5/8" x 4"				1
AS-584-4PK [Ⓢ]	(4) 5/8" x 4"				4

Extruded Bumper Stops

Ideal for building and machinery protection. Bumper Stops are excellent for protecting vehicles when parking places are located next to building walls and trucks at docks. Made of strong, durable, high impact resistant solid rubber. Easy installation either horizontally or vertically. Accepts a ⅜" flat head anchor bolt. Installation hardware available separately, see below.



model BS-18

48 Hours
to Ship

MODEL NUMBER	WIDTH	LENGTH	PROJECTION	# OF HOLES & SIZE	NET WT. (LBS.)
BS-12 [Ⓢ]	5½"	12"	1¼"	2, 3/8"	4
BS-18 [Ⓢ]	5½"	18"	1¼"	2, 3/8"	5
BS-24 [Ⓢ]	5½"	24"	1¼"	3, 3/8"	7
BS-36 [Ⓢ]	5½"	36"	1¼"	4, 3/8"	10
ANCHOR BOLTS HARDWARE FOR CONCRETE INSTALLATION					
AS-383 [Ⓢ]	(1) 3/8" x 3"				1
AS-383-4PK [Ⓢ]	(4) 3/8" x 3"				4

Rounded Dome Bumpers

Great for use under equipment for protecting surfaces. Isolate equipment from impact and vibration. Non-marking polyurethane rubber material. Pressure sensitive adhesive backing to peel and stick.

48 Hours
to Ship

MODEL NUMBER	DIAMETER	HEIGHT	PACKAGE QUANTITY	NET WT. (PER PKG. POUNDS)
RDB-075 [Ⓢ]	3/4"	0.375"	50	1
RDB-125 [Ⓢ]	1¼"	0.625"	25	1
RDB-200 [Ⓢ]	2"	1.000"	15	1
RDB-250 [Ⓢ]	2½"	1.250"	10	2

Pallet Pullers

Pallet Pullers are used to pull pallets to rear of trailers for easy fork truck access. Rugged steel construction. Heads are self-cleaning and unaffected by wood particles, paint, or grease. Pallet pullers are NOT designed for lifting.

PAL-12 and PAL-16 - Single scissor action allows for wider jaw opening.

PAL-14 - Cam closing action provides maximum gripping strength and reduces pinch points. Safety handle enables easier positioning and removal. Grips both metal and wood pallets with biting action.

PAL-21 and PAL-LP - One piece curved heads have integral spurs for gripping pallet stringers.

MODEL NUMBER	DESCRIPTION	UNIFORM PULLING CAPACITY	JAW HEIGHT	JAW OPENING	NET WT. (LBS.)
PAL-12	SINGLE SCISSOR	5,000 lbs.	2¾"	7"	14
PAL-16	HEAVY-DUTY SINGLE SCISSOR	6,000 lbs.	2"	5"	21
PAL-14	CAM ACTION	5,000 lbs.	1½"	3"	17
PAL-21	DOUBLE SCISSOR	5,000 lbs.	2¾"	3"	25
PAL-LP	LOW PROFILE DOUBLE SCISSOR	5,000 lbs.	2"	3¼"	24
PPC-20	20' OF ¼" CHAIN W/GRAB HOOKS	6,000 lbs.	---	---	14
PPC-40	40' OF ¼" CHAIN W/GRAB HOOKS	6,000 lbs.	---	---	28

NOT FOR LIFTING



Prylever Bars

Provide dock workers, riggers, and freight handlers with the leverage needed to get underneath heavy objects for transporting with fork truck, hand truck, pallet truck, or machinery movers. Two (2) 5" x 2" poly-on-steel wheels. 6"W x 8"D (6"W x 3½"D usable) x ½" thick steel nose plate with beveled edge is bolted on the wood handle units and welded on the steel units. Steel units feature powder coat blue finish.

MODEL NUMBER	DESCRIPTION	BAR LENGTH	UNIFORM CAPACITY (POUNDS)	NET WT. (LBS.)
PLB-5	WOOD PRYLEVER BAR	5'	4,250	31
PLB-6	WOOD PRYLEVER BAR	6'	4,250	32
PLB-7	WOOD PRYLEVER BAR	7'	4,250	35
PLB/S-5	STEEL PRYLEVER BAR	5'	5,000	37
PLB/S-6	STEEL PRYLEVER BAR	6'	5,000	42
PLB/S-7	STEEL PRYLEVER BAR	7'	5,000	47*



Pallet Buster

Refurbish or remove broken and unsightly pallets quickly and safely. Lightweight and easy to use. Can be utilized to raise a dockboard for fork truck removal. Model SKB-7 features a unique dual prying action with nail puller.

MODEL NUMBER	DESCRIPTION	BAR LENGTH	HANDLE DIAMETER	NET WT. (LBS.)
SKB-7	PALLET BUSTER	41½"	1¼"	9
SKB-DLX	DELUXE PALLET BUSTER	41"	1¼"	16



Security Seals

Seal trailers, gates, hatches, and doors with these general purpose security seals. Reveals the slightest tampering attempts. Two (2) colors and four (4) styles to choose from. Polypropylene construction. Sold only in packages of 100.

MODEL NUMBER	STAMPED MARKINGS	LENGTH	SEQUENTIALLY NUMBERED	NET WT. (LBS.)
SECS-B9-BL	SEALED - DO NOT REMOVE	14⅞"	NO	2
SECS-B9-RD	SEALED - DO NOT REMOVE	14⅞"	NO	2
SECS-F7-BL	SEALED	8⅞"	YES	1
SECS-F7-RD	SEALED	8⅞"	YES	1
SECS-L11-BL	SEALED	15"	YES	2
SECS-L11-RD	SEALED	15"	YES	2
SECS-P-BL	SEALED	3"	YES	1
SECS-P-RD	SEALED	3"	YES	1



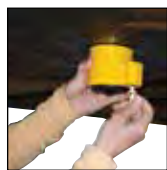

Economy Trailer King Pin Lock

Trailer King Pin Lock provides security for trailers and RV's. Lock slides onto a trailer's king pin to prevent a thief from pulling up, hitching, and driving off with your trailer. No tools are required, just slide the king pin lock into place and turn the key. Units are powder coated yellow and come with two (2) keys, keyed alike.

MODEL NUMBER	DESCRIPTION	HEIGHT	INSIDE DIAMETER	NET WT. (LBS.)
E-TKPL [®]	KING PIN LOCK	3¼"	3"	3



48 Hours
to Ship

POWDER COATED
TOUGH

Installation Hardware

Secure your product to a concrete surface. Works with a wide variety of equipment which is featured throughout this catalog.

New



model AS-344-4PK

48 Hours
to Ship



model BIT-1/2

MODEL NUMBER	DIAMETER	OVERALL LENGTH	SLEEVE LENGTH	QUANTITY	NET WT. (POUNDS)
AS-125 [®]	1/2"	5½"	3"	1	1
AS-125-4PK [®]	1/2"	5½"	3"	4	4
AS-383 [®]	3/8"	3"	1"	1	1
AS-383-4PK [®]	3/8"	3"	1"	4	4
AS-344 [®]	3/4"	4¼"	2"	1	1
AS-344-4PK [®]	3/4"	4¼"	2"	4	4
AS-346 [®]	3/4"	6¼"	3"	1	1
AS-346-4PK [®]	3/4"	6¼"	3"	4	4
AS-584 [®]	5/8"	4"	3"	1	1
AS-584-4PK [®]	5/8"	4"	3"	4	4
CONCRETE DRILL BIT					
BIT-3/8 [®]	3/8"	6"	---	1	1
BIT-1/2 [®]	1/2"	6"	---	1	1
BIT-3/4 [®]	3/4"	6"	---	1	1

RR, EH or RU DOCK LEVELER

EXISTING PIT SURVEY SHEET

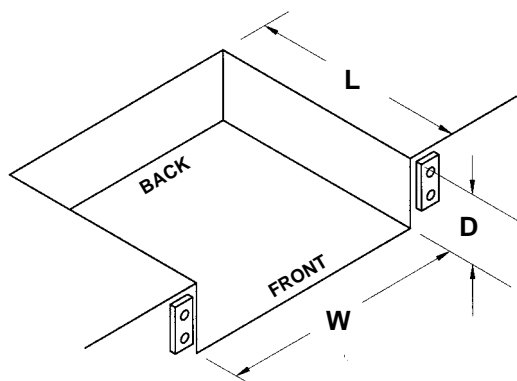

CUSTOMER INFORMATION

CONTACT: _____
 COMPANY: _____
 PHONE: _____
 EMAIL: _____

SPECIFICATIONS

CIRCLE ONE:

MECHANICAL ELECTRIC HYDRAULIC TRUCK ACTUATED

CAPACITY:	20,000	25,000	30,000	35,000
	40,000	45,000	50,000	60,000
	70,000	80,000	90,000	100,000

EXISTING PIT SPECIFICATIONS

WIDTH (W): _____
 LENGTH (L): _____
 FRONT DEPTH (D): _____
 BACK DEPTH (D): _____

**** MEASURE PIT NOT EXISTING DOCK LEVELER ****

CUSTOMER INFORMATION

CONTACT: _____
 COMPANY: _____
 PHONE: _____
 EMAIL: _____

DOOR SIZE

(W) WIDTH OF OPENING: _____ (inches)
 (H) HEIGHT OF OPENING: _____ (inches)
 (LC) LEFT CLEARANCE: _____ (inches)
 (RC) RIGHT CLEARANCE: _____ (inches)
 (TC) TOP CLEARANCE: _____ (inches)
 (E) EXTENSION FROM BUILDING: _____ (inches)
 (DB) DOCK BUMPER PROJECTION: _____ (inches)
 (DH) DOCK HEIGHT: _____ (inches)
 IS THIS DOOR NEXT TO ANOTHER DOOR THAT REQUIRES A SEAL/SHELTER? _____
 WILL/DOES THIS DOOR HAVE A FACE MOUNTED EDGE-O-DOCKLEVELER? _____

SPECIAL SIZE TRAILERS

HIGHEST TRAILER: _____ (inches)
 LOWEST TRAILER: _____ (inches)
 WIDEST TRAILER: _____ (inches)
 NARROWEST TRAILER: _____ (inches)

BUILDINGS WITH SLOPED DOCK APPROACH

(A) DISTANCE BETWEEN TRAILER AND BUILDING AT POINT A: _____ (inches)
 (B) DISTANCE BETWEEN TRAILER AND BUILDING AT POINT B: _____ (inches)

**D-150, D-350,
 D-150/650 D-750
 DOCK SEAL &
 DOCK SHELTER**

SURVEY SHEET

