



**Material
Handling**
Product Line

The material matters in material handling

Order From
Dick Jones Sales, Inc.
PO Box 141
Hanover, PA 17331
P 800-441-9955
F 800-253-4036
Email: dickjones@dickjonessales.com



MFG
TRAY

OPTIMAL PERFORMANCE AND VALUE



MFG Tray products are molded from high-strength, glass-reinforced composites. The fiber component provides strength and dimensional stability, while the plastic resin provides specific chemical, electrical and thermal properties. The outstanding physical properties for which these products are known are a result of the synergy of resin matrix and glass reinforcement. Most MFG Tray products are compression molded from our own sheet-molding compound (SMC), a process that is ideal for producing medium to high volumes of high-strength, complex parts.

Unlike plastic trays and containers, composite products are dimensionally stable and will not bend or sag under heavy loads. And unlike metal, they will not dent, corrode or bend. Thanks to their strength, composite products may be readily stacked to save space and streamline handling and product storage. The durability that results from composite construction ensures years of dependable performance.

EXCEPTIONAL PERFORMANCE AND DURABILITY

Thanks to their composite design, MFG Tray products offer substantial strength and weight-carrying capacity resulting in exceptional stacking capability under heavy loads. They are also ideal for machine integration and robotic applications, and can be used continuously in temperatures ranging from -60° to 250° F (-51° to 121° C), and intermittently in temperatures 300° F and higher. Glass-reinforced thermosets increase impact strength as temperatures decrease, and MFG products have performed well in temperatures as low as -190° F. Standard formulations are impervious to radiation, cutting oils, detergents, mild acids and alkaline solutions ranging from 3.0 to 10.0 pH. Models are available that may be used in chemical solutions from 3.0 to 12.0 pH. The standard formulation meets the requirements of UL 94 HB flammability rating.

VARIETY OF SIZES AND CONFIGURATIONS

The MFG Tray material handling line is comprised of over 300 different containers for general and specific processing, conveying, transporting, and storing requirements. In addition, MFG Tray offers modifications such as handholds, drain holes, drop handles, grommets, casters, and dollies to meet specific application needs. Wire-rim reinforcement is available on certain products for added dimensional stability.

MFG Tray's high-strength, glass-reinforced composite containers, trays, boxes, flats, and totes proudly serves the material handling (metalworking, plastics, and electronics assembly), food service, confectionery, farming, and pharmaceutical industries. The company continually develops customized solutions for specific material handling challenges and applications. Customers are encouraged to contact MFG Tray to discuss any unique handling and design requirements.

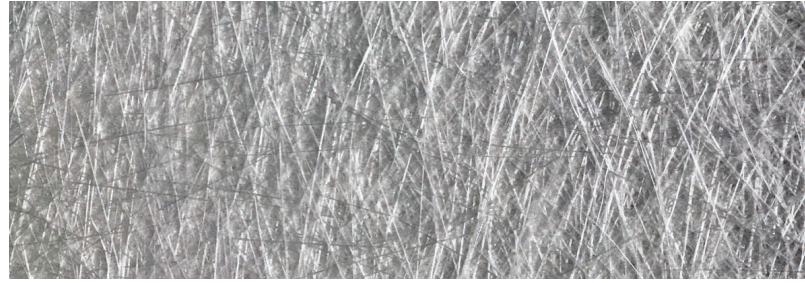

STRENGTH AT THE CORE. Fibers in MFG Tray products are multi-directional or random for optimal tensile and torsion strength of the finished part. Fiber lengths vary from 1" to 2". The composites can contain up to 35 percent of randomly oriented fibers by weight.

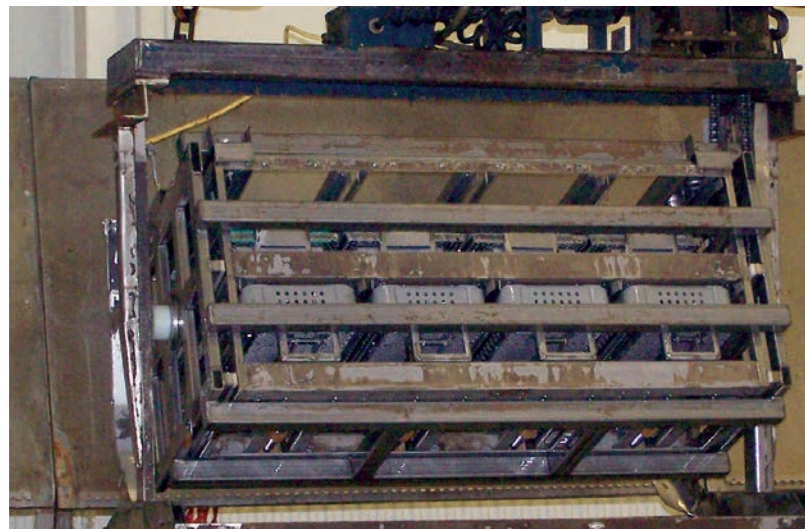
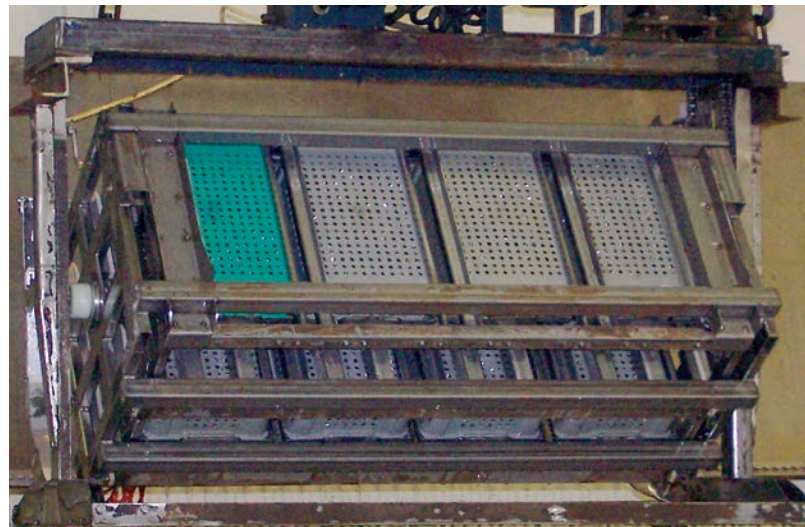

EFFICIENT STORAGE AND HANDLING WITH OUTSTANDING DURABILITY. MFG Tray containers are available in a variety of sizes and designs to readily accommodate an array of end products. Several units portrayed here have been in service for 20 years.



HIGHLY FUNCTIONAL. Ideal for heavy-duty storage, work-in-progress or distribution applications.

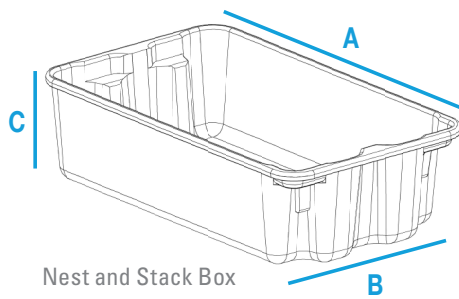

Nest and Stack Box



Nest and Stack Box
Model No. 780408
Green



Lid
Model No. 780418
Green



Dolly
Model No. 780438
Green

TOTELINE™ NEST AND STACK CONTAINERS 780 SERIES

- » Nest and stack design saves valuable space: stack when full, rotate 180 degrees and nest when empty
- » Lids are available to protect contents
- » Optional dollies simplify transport
- » Containers can be stacked on lids
- » Impervious to cutting oils, detergents, mild acids, and alkaline solutions
- » High operating temperatures -60° to 250°F (-51° to 121°C)
- » High weight capacity

Product Name	Outside Top (inches)			Inside Bottom (inches)			Model No.
	A	B	C	A*	B	C	
Nest & Stack Box	42 1/2	20	14 1/4	35 7/8	17 3/8	14 1/8	780008
Nest & Stack Box	42 1/2	20	7 1/2	35 7/8	17	7 1/4	780108
Lid for 780008 & 780108	42 1/2	20	1 3/16				780118
Nest & Stack Box	17 7/8	10 5/8	5	14 1/8	9 1/2	4 7/8	780208
Lid for 780208	17 7/8	10 5/8	1 3/16				780218
Dolly with 3" dia. swivel casters							780238
Nest & Stack Box	19 3/4	12 1/2	6	16 1/4	11 3/8	5 7/8	780308
Lid for 780308	19 3/4	12 1/2	1 3/16				780318
Dolly with 3" dia. swivel casters							780338
Nest & Stack Box	20 1/2	12 7/8	8	16 3/8	11	7 7/8	780408
Lid for 780408	20 1/2	12 7/8	1 3/16				780418
Dolly with 3" dia. swivel casters							780438
Nest & Stack Box	24 1/4	14 3/4	8	18 1/2	12 3/4	7 7/8	780508
Lid for 780508	24 1/4	14 3/4	1 3/16				780518
Dolly with 3" dia. swivel casters							780538
Nest & Stack Box	25 1/4	18	10	20	16	9 7/8	780608
Lid for 780608/808	25 1/4	18	1 1/4				780618
Dolly with 3" dia. swivel casters							780638
Nest & Stack Box	27 1/2	20	14 1/8	24 7/8	17 3/8	13 1/8	780708
Lid for 780708	27 1/2	20	1 1/4				780718
Dolly with 3" dia. swivel casters							780738
Nest & Stack Box	25 1/4	18	6	20	16	5 3/4	780808

*Bottom length dimension (A) taken between minimum inside clearance.

STANDARD COLORS

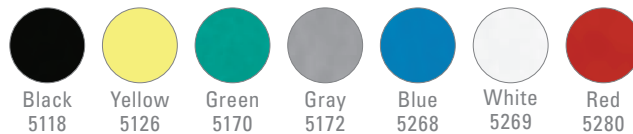

Black 5118 Yellow 5126 Green 5170 Gray 5172 Blue 5268 White 5269 Red 5280

NEST AND STACK CONTAINERS OTHER MODELS

Product Name	Outside Top (inches)			Inside Bottom (inches)			Model No.
	A	B	C	A	B	C	
Nest & Stack Box	19 5/8	12 5/8	8	16 3/4	8 3/8	7 7/8	702008
Lid for 702008	19 5/8	12 5/8	27/32				702118
Nest & Stack Box	24	20	12 3/4	20 1/2	14 1/8	12 3/4	703008
Nest & Stack Box	21 1/8	15 5/8	6	19 1/4	13 5/8	5 7/8	705108
Nest & Stack Box	24	14 3/8	7 3/4	21 5/8	11 5/8	7 5/8	705208
Lid for 705208	24	14 3/8	13/16				705211
Dolly with 3" dia. swivel casters							705231
Nest & Stack Box	17 7/8	11 1/4	6	15 5/8	8 5/8	5 7/8	705308
Nest & Stack Box	23 1/2	16 1/8	10 1/4	20 7/8	12 7/8	10 1/4	705408
Lid for 705408	23 1/2	16 1/8	13/16				705411
Dolly with 3" dia. swivel casters							705431
Nest & Stack Box	19 1/2	12 1/2	6	16 7/8	9 1/2	5 7/8	710008
Lid for 710008	19 5/8	12 5/8	27/32				710118

STANDARD COLORS

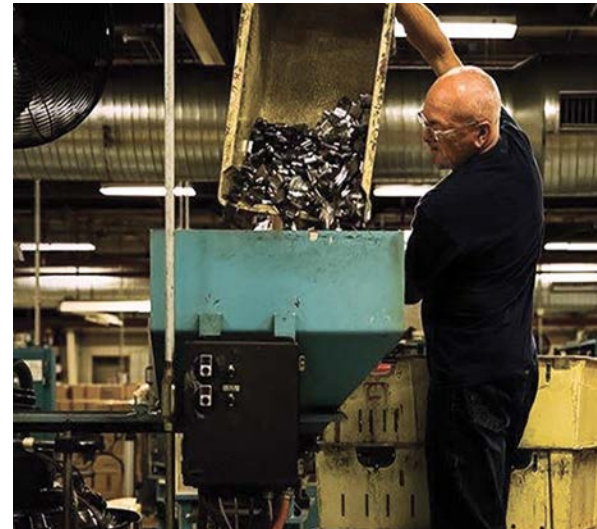
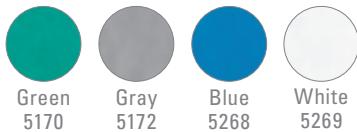

EXCEPTIONAL PERFORMANCE.
Featuring a smooth outside surface and radial edges for safe and easy handling.



Nest and Stack Box
Model No. 705408 with
Model No. 705411 Lid
White



Dolly
Model No. 705431
White



DESIGNED TO FIT. MFG Tray's Nest and Stack line is the epitome of smart storage. Designed to handle tough loads when working and stack efficiently while waiting to work. (Shown: the 780 Series on the left and various other Nest and Stack options on the right.)

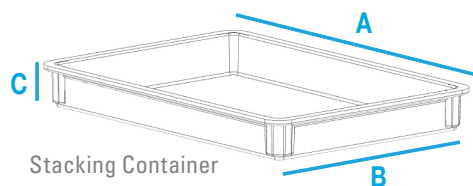

Stacking Container

STACKING CONTAINERS

- » Ideal for forgings, machined parts, stampings, ceramics, rubber, and other hot parts emerging from molds or processing machines
- » Easily cleaned in hot water or steam with standard detergents
- » Impervious to cutting oils, detergents, mild acids, and alkaline solutions
- » High operating temperatures -60° to 250°F (-51° to 121°C)
- » Optional lids and dollies available



Stacking Boxes
Model No. 804008
Green



Stacking Boxes
Model No. 819008
Green

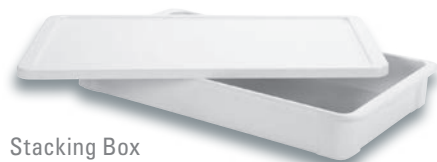

Stacking Box
Model No. 808208 with
Model No. 808218 Lid
White



Stacking Boxes
Model No. 808208, 808308 and 808408
White

Product Name	Outside Top (inches)			Inside Bottom (inches)			Model No.
	A	B	C	A	B	C	
Stacking Box	24 1/2	21 1/4	2 5/8	23 3/8	20 1/8	2 1/2	220008
Stacking Box	27	21	2 5/8	26	20	2 1/2	221008
Stacking Box	31 3/4	19 1/8	4 1/2	29 3/4	18	4	800108
Stacking Box	20 5/8	11 1/4	5 1/2	18	10	5 3/8	801108
Lid for 801108	20 1/8	11 1/4	5/8				801111
Stacking Box	16 1/2	11 3/8	4 5/8	14 5/8	10 1/2	4 1/2	802008
Stacking Box	18 3/4	11 7/8	1 3/4	17	11	1 5/8	804008
Stacking Box	30 3/8	15 7/8	2 3/4	29 5/8	15 1/8	2 5/8	805108
Stacking Tray	25 3/4	17 3/4	1 1/8	24 3/4	16 3/4	1	806001
Stacking Box	18 1/2	12 1/2	1/4	18	12	1/8	807001
Stacking Box	22	12	1 1/4	21 1/8	11 1/8	1 1/4	808108
Stacking Box	23 3/8	12	3 1/8	21 1/8	11 1/8	3	808208
Stacking Box	23 3/8	12	6	21	11	5 7/8	808308
Stacking Box	23 3/8	12	4 3/8	21	11	4 1/4	808408
Lid for 808208, 808308 and 808408							808218
Stacking Tray	18	16	1/2	17 1/4	15 1/4	3/8	810008
Stacking Box	22 1/8	10 5/8	8	18 3/4	8 3/4	7 7/8	811108
Stacking Box	16 7/8	9 1/2	6 1/4	14 5/8	7 3/4	6 1/8	812108
Stacking Box	20 3/4	11 1/4	3 1/4	18 7/8	9 1/2	3 1/8	814108
Stacking Box	20 3/4	11 1/4	5	18 1/2	9 3/4	4 7/8	814208
Stacking Box	25 3/4	15 3/4	7 1/4	23 1/2	14	7 1/8	814308
Stacking Box	33 1/8	15 5/8	8	30 3/4	14 1/4	7 7/8	814408
Stacking Box	13	10 1/2	5	10 5/8	8 5/8	4 7/8	814608
Stacking Box	20 3/4	11 1/4	2 3/8	18 5/8	9 3/4	2 1/4	814708
Stacking Box	29	25	5	28 1/4	24 1/4	4 7/8	815008
Stacking Box	17 1/2	17 1/2	4 1/2	15 5/8	16	4 3/8	817008
Stacking Box	34 1/4	32 1/4	2 3/4	33 1/2	31 1/2	2 5/8	818001
Stacking Box	17 3/4	10 1/2	4 1/8	15 5/8	9 1/2	4	819008
Stacking Tray	23	16 3/4	1 1/8	21 3/8	15 1/2	1	820108
Stacking Box	14 3/4	14 3/8	3 1/2	12 7/8	12 7/8	3 3/8	825008
Stacking Box	27 1/4	12 1/2	5 3/4	23 1/4	10 1/2	5 5/8	828008
Stacking Box	37 1/2	24 1/4	19	35 1/4	19 1/4	18 5/8	841108
Stacking Box	37 1/2	24 1/4	9 1/2	35	19	8 1/8	841208
Stacking Box	27 1/8	12	2 7/8	24 1/4	11 1/8	2 3/4	846108
Stacking Box	27 1/8	12	6 7/8	24	10 7/8	6 3/4	846208
Stacking Tray	26	20	1 1/2	25 3/8	19 3/8	1 3/8	848008

STACKING CONTAINERS

Product Name	Outside Top (inches)			Inside Bottom (inches)			Model No.
	A	B	C	A	B	C	
Stacking Box	28	28	12	24 ⁵ / ₈	24 ⁵ / ₈	11 ³ / ₄	865008
Stacking Box	30	17 ³ / ₄	2 ¹ / ₄	26 ¹ / ₂	16	1 ⁷ / ₈	867008
Stacking Box	25 ³ / ₄	17 ³ / ₄	3	23 ⁷ / ₈	15 ⁷ / ₈	2 ⁷ / ₈	870008
Stacking Box	22	11 ¹ / ₂	4 ¹ / ₄	20 ¹ / ₈	10 ¹ / ₂	4 ¹ / ₈	871008
Stacking Box	23	19	9 ⁵ / ₈	21 ⁵ / ₈	17 ⁵ / ₈	9 ¹ / ₂	872008
Stacking Box	36	24	5	35 ¹ / ₈	23 ¹ / ₈	4 ⁵ / ₈	874001
Stacking Box	25 ³ / ₄	17 ³ / ₄	4 ¹ / ₂	23 ⁷ / ₈	15 ⁷ / ₈	4 ¹ / ₂	875008
Stacking Box	25 ³ / ₄	17 ³ / ₄	6	23 ⁷ / ₈	15 ⁷ / ₈	5 ³ / ₄	880008
Dolly for 870008, 875008 and 880008							870148
Lid for 870008, 875008 and 880008							887008
Stacking Box	25	20	3	23	18 ¹ / ₂	2 ⁷ / ₈	893008
Stacking Box	28	20	3	26	18 ¹ / ₂	2 ⁷ / ₈	893108
Stacking Box/drop sides	35 ³ / ₄	19 ³ / ₄	3 ³ / ₄	34	17 ⁷ / ₈	3 ¹ / ₂	894008
Stacking Box	29	18	2	25 ⁷ / ₈	16 ⁷ / ₈	1 ⁷ / ₈	895008
Stacking Box	30 ¹ / ₂	20 ¹ / ₂	3 ¹ / ₂	28 ³ / ₄	18 ³ / ₄	3 ³ / ₈	896108
Stacking Box	30 ¹ / ₂	20 ¹ / ₂	6 ¹ / ₄	28 ³ / ₄	18 ³ / ₄	6	897108
Stacking Box	30 ¹ / ₂	20 ¹ / ₂	7 ¹ / ₂	28 ³ / ₄	18 ³ / ₄	7 ³ / ₈	898108
Stacking Box	28 ¹ / ₄	20	3	26 ³ / ₈	18	2 ⁷ / ₈	899108

STANDARD COLORS

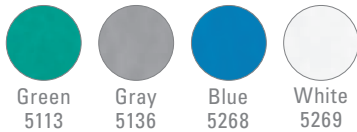

Stacking Boxes
Model No. 887008 Lid,
870008, 875008, 880008
and 870148 Dolly
Gray



Stacking Container
Model No. 870008
White



HANDLES THE HEAT. Operating temperature range of -60° to 250° F (-51° to 121° C) enables MFG Tray products to readily handle forgings, castings and other end products processed with heat.



STRENGTH AND STABILITY. Composite construction ensures unit strength and stacking stability without sag or distortion.

NESTING CONTAINERS

- » Ideal for small parts handling, storing, and shipping
- » Used in healthcare, autoclaving, and cryogenic applications
- » Strength-to-weight ratio exceeds aluminum or steel
- » Available in a variety of designs to function as drawers, trays, pans and containers
- » Impervious to cutting oils, detergents, mild acids, and alkaline solutions
- » High operating temperatures -60° to 250°F (-51° to 121°C)
- » Optional lids on certain models for stacking and parts protection

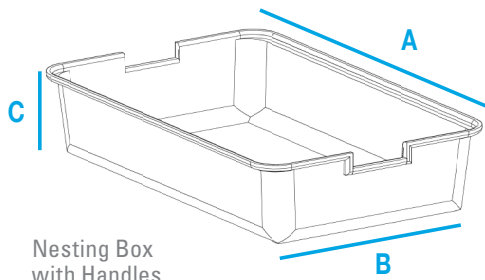

Nesting Box with Handles

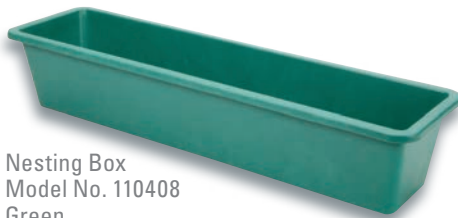

Nesting Box
Model No. 110408
Green



Nesting Box
Model No. 330008 with
Model No. 330118 Lid
White



Nesting Boxes (Nested)
Model No. 506008
Beige



Nesting Box with Lid
Model No. 912208
Blue

Product Name	Outside Top (inches)			Inside Bottom (inches)			Model No.
	A	B	C	A	B	C	
Nesting Box	18	7	5	15 3/8	4 3/4	4 3/4	110108
Nesting Box	24	8	6	21 1/8	4 3/4	5 3/8	110208
Nesting Box	36	8	6	31 1/4	4 3/4	5 3/4	110408
Nesting Box	21 1/2	11	2 1/2	20	9 5/8	2 1/8	110508

Standard Colors: Gray 5116, Green 5105, White 5232

Nesting Box	21 1/4	15	5	18 1/8	13 1/8	4 7/8	330008
Lid	21 1/4	15	3/8	18 3/4	14	1/4	330118
Nesting Box	20 1/4	12	5	17 3/4	10 3/8	4 7/8	331008
Nesting Box	20 3/4	15 3/8	5	17 7/8	13 5/8	4 7/8	336001
Nesting Tray	20 3/4	12 3/4	2 1/2	17 1/2	9 1/2	2	344008

Standard Colors: Blue 5268, Gray 5136, Green 5113, White 5269

Nesting Box	19 1/2	13 1/2	4 1/8	18 1/8	11 1/2	4	500008
Nesting Box	19 1/2	12 1/2	4 1/8	18 1/8	10 1/2	4	502008
Nesting Box	19 1/2	13 1/2	4 1/2	18 1/8	11 1/2	4	504008
Nesting Box	19 1/2	9 1/2	4 1/8	18 1/8	7 1/2	4	505008
Nesting Box	19 1/2	13 1/2	4	18 1/4	11 3/8	3 7/8	506008
Nesting Box	19	7 1/2	4	17 3/4	5 3/8	3 7/8	507008
Nesting Box	20	15 7/8	4 1/2	18 1/8	14 5/8	4 1/8	508108
Nesting Box	13 1/4	12 1/2	3 1/2	12 1/8	10 5/8	3 3/8	509008

Standard Colors: Beige 5258, Gray 5136, White 5269

Nesting Box	37 1/4	18	3 7/8	36	16 3/4	3 3/4	900001
Nesting Box	17	11	5	14 1/4	9 5/8	4 7/8	902008
Nesting Box	16 1/2	12	10	14 7/8	10 3/8	9 7/8	903108
Lid for 903108	16 1/2	12	19/32				903118
Nesting Box	16	11 1/2	4	14 3/4	10 3/8	3 7/8	903208
Nesting Box	22	16 1/2	8 1/2	19 1/4	14 5/8	8 3/8	908208
Nesting Box	23 1/4	17 1/4	10 3/8	21 3/8	15 3/4	10 1/4	911001
Nesting Box	22 5/8	17 1/4	14	20 1/2	15	13 7/8	912108
Lid for 912108, 912208	23	17 5/8	1/8				912118
Nesting Box	22 3/8	17	10	20 1/2	15	9 7/8	912208
Nesting Box	20 1/2	17	10 3/8	17 1/4	14 3/4	10 3/8	919108
Lid for 919108, 919208	20 1/2	17	5/8				919118
Nesting Box	20 1/2	17	12	17 1/4	14 3/4	12	919208

Standard Colors: Blue 5268, Gray 5136, Green 5113, White 5269

NESTING CONTAINERS

Product Name	Outside Top (inches)			Inside Bottom (inches)			Model No.
	A	B	C	A	B	C	
Nesting Box	11 ³ / ₄	8 ³ / ₄	4 ¹ / ₈	11	8	4	920108
Lid for 920108	11 ³ / ₄	8 ³ / ₄					920118
Nesting Box	6 ¹ / ₈	4 ⁷ / ₈	2 ¹ / ₈	5 ¹ / ₂	4 ¹ / ₄	2	921108
Lid for 921108	6 ¹ / ₈	4 ⁷ / ₈					921118
Nesting Box	9 ³ / ₄	6 ¹ / ₈	2 ¹ / ₈	8 ⁷ / ₈	5 ¹ / ₄	2	922108
Lid for 922108, 926108	9 ³ / ₄	6 ¹ / ₈					922118
Nesting Box	9 ³ / ₄	9 ¹ / ₄	4 ¹ / ₂	9	8 ³ / ₈	4 ³ / ₈	923108
Lid for 923108, 924108	9 ³ / ₄	9 ¹ / ₄					923118
Nesting Box	9 ³ / ₄	9 ¹ / ₄	2 ¹ / ₈	8 ⁷ / ₈	8 ³ / ₈	2	924108
Nesting Box	20 ¹ / ₂	17	10 ³ / ₈	17 ⁷ / ₈	14 ³ / ₈	10	925108
Nesting Box	9 ³ / ₄	6 ¹ / ₈	4 ¹ / ₂	9	5 ¹ / ₄	4 ³ / ₈	926108
Lid for 922108, 926108	9 ³ / ₄	6 ¹ / ₈					922118
Nesting Box	42	18	5	40 ¹ / ₄	16 ¹ / ₄	4 ⁷ / ₈	927008
Nesting Box	26	18	5	24 ¹ / ₄	16 ¹ / ₄	4 ⁷ / ₈	928008
Nesting Box	22	16 ¹ / ₂	4 ¹ / ₄	19 ¹ / ₈	14 ⁵ / ₈	4	929008
Nesting Box	12 ³ / ₈	9 ³ / ₄	2 ¹ / ₈	11 ¹ / ₂	8 ⁷ / ₈	2	930108
Lid for 930108	12 ³ / ₈	9 ³ / ₄					930118
Nesting Box	28 ⁷ / ₈	20 ³ / ₈	10	26 ³ / ₄	18	9 ³ / ₄	931008
Nesting Box	11 ³ / ₈	9 ¹ / ₄	3 ³ / ₈	10 ³ / ₈	8 ³ / ₄	3 ¹ / ₄	940108
Lid for 940108	11 ³ / ₈	9 ¹ / ₄					940118

STANDARD COLORS

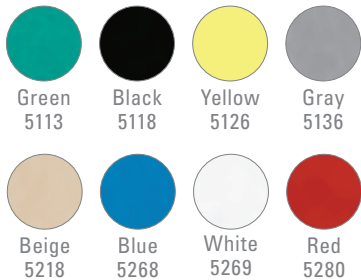

IMPRESSIVE STRENGTH AND STABILITY. Design saves valuable floor and bench space.

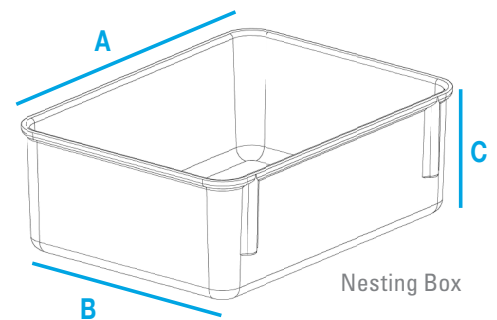

Nesting Box
Model No. 921108 with
Model No. 921118 Lid
Red



Nesting Boxes (Nested)
Model No. 923108
Gray



KINDER THAN METAL. Composite containers are easier on end products than metal baskets and eliminate the damage or hazard posed by broken wire baskets.

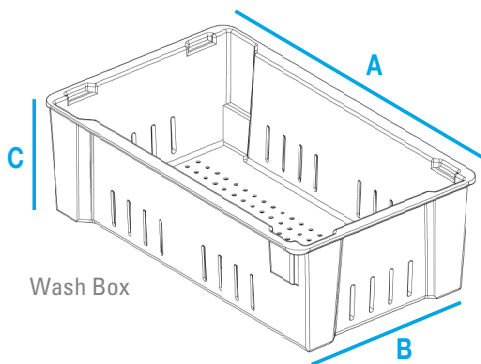

WASH BOXES

- » 1/3 the cost of stainless steel wire baskets
- » Stackable containers are impervious to washing chemicals
- » Operating temperatures to 250° F; intermittently to 300° F
- » Handles up to 150 pounds payload
- » Ideal for cleaning, storing and inventorying of small parts; easier on parts than metal
- » Washing, draining and drying may be accomplished without parts transfer
- » Holes are 1/4" diameter; slots are 2 1/2" x 5/16"; other hole sizes are available

WASH BOXES - NEST & STACK STYLE

Product Name	Outside Top (inches)			Inside Bottom (inches)			Model No.
	A	B	C	A	B	C	
Nest & Stack Box	17 7/8	11 1/4	6	15 5/8	8 5/8	5 7/8	705348 1205
Nest & Stack Box	21 1/8	15 5/8	6	19 1/4	13 5/8	5 7/8	705148 1206
Nest & Stack Box	24	14 3/8	7 3/4	21 5/8	11 5/8	7 5/8	705248 0945

STANDARD COLORS



Gray
5136

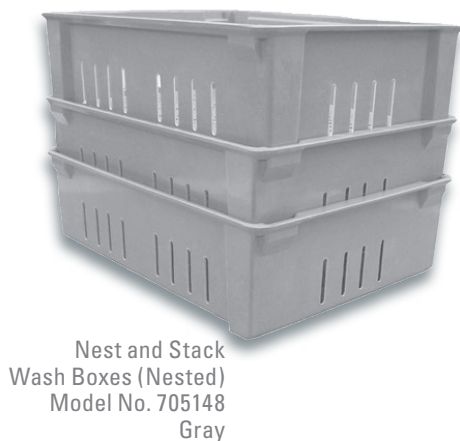

EFFICIENT HANDLING AND STORAGE. Versatility to be used for cleaning, inventory and storage of small parts, and often eliminate the need for dumping product into special containers for the washing process.

EASY DOES IT. Side slots and holes in the bottom ensure thorough rinsing and draining. Contour design with rounded corners eliminates the safety hazards inherent with sharp metal containers.



WASH BOXES - STACKING STYLE

Product Name	Outside Top (inches)			Inside Bottom (inches)			Model No.
	A	B	C	A	B	C	
Stacking Box	16 1/2	11 3/8	4 5/8	14 5/8	10 1/2	4 1/2	802048 1148
Stacking Box	17 3/4	10 1/2	4 1/8	15 5/8	9 1/2	4	819048 2585
Stacking Box	20 5/8	11 1/4	5 1/2	18	10	5 3/8	801148 1204
Stacking Box	20 3/4	11 1/4	5	18 1/2	9 3/4	4 7/8	814248 1207
Stacking Box	23 3/8	12	4 3/8	21	11	4 1/4	808448 2735
Stacking Box	23 3/8	12	6	21	11	5 7/8	808348 1203
Stacking Box	25 3/4	17 3/4	4 1/2	23 7/8	15 7/8	4 1/2	875048 1153

STANDARD COLORS



Gray
5136



Stacking Wash Box
Model No. 802048
Gray



Stacking Wash Boxes
Model No. 819048
Special Order Green



UTILITY PLAYERS. Smooth, rounded edges and balanced, ergonomic design ensure stable handling. (Custom color shown.)

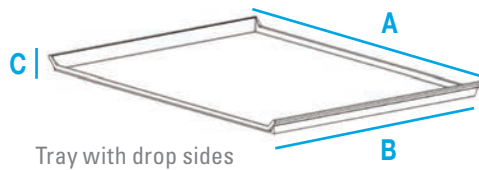

Tray
Model No. 217101
White

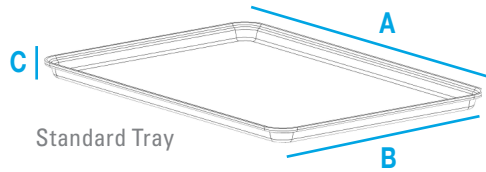

Tray
Model No. 228008
Gray

CONVEYOR AND ASSEMBLY TRAYS

- » Can be readily integrated into automated systems
- » Low profile and radius edges facilitate use with conveyors and racks
- » Exceptional temperature compatibility
- » Wide variety of sizes and configurations to accommodate a range of operating requirements
- » Impervious to cutting oils, detergents, mild acids, and alkaline solutions
- » High operating temperatures -60° to 250°F (-51° to 121°C)

Product Name	Outside Top (inches)			Inside Bottom (inches)			Model No.
	A	B	C	A	B	C	
Tray	24 1/2	21 1/8	1	23 1/2	20 3/8	7/8	204101
Tray	25 1/2	22 1/2	1	24 1/2	21 3/4	7/8	205101
Tray	24 1/2	22 1/2	1	23 1/2	21 3/4	7/8	206101
Tray	27 7/8	22 3/8	1	26 7/8	21 3/4	7/8	207101
Tray	23 1/4	20 3/8	1	22 5/8	19 1/4	7/8	208101
Tray	24 1/2	21 1/2	1	23 1/2	20 3/4	7/8	209101
Tray	27	21	1	26	20 1/4	7/8	210101
Tray	26 1/4	22	1	25 1/4	21 1/4	7/8	211101
Tray	28	21 1/2	1	27	20 3/4	7/8	212101
Tray	26 1/4	23	1	25 1/4	22 1/4	7/8	213101
Tray	24 1/2	23	1	23 1/2	22 1/4	7/8	214101
Tray	34 1/4	21 3/8	1	33 1/4	20 5/8	7/8	215101
Tray	27	20	1	26	19 1/4	7/8	217101
Tray	22 1/2	20	1	21 3/8	19 1/4	7/8	218101
Pallet	22	22	3/4	20 7/8	20 7/8	5/8	228008
Tray	16 3/8	12	1	15	10 1/2	5/8	302001
Tray	13 3/4	10 5/8	1	12 1/2	9 1/8	5/8	303001
Tray	20 3/8	15 1/8	1	18 3/8	13 1/4	3/4	304001
Tray	21 7/8	16	1	20 3/8	14 3/8	3/4	305001
Tray	22 1/2	16 1/2	1	20 7/8	14 3/4	3/4	308001
Tray	18	14	1	16 1/2	12 1/2	3/4	318001
Tray	16	12	5/8	16 3/4	12 3/4	1/2	321001
Tray	12 3/4	10 1/2	5/8	11 3/8	9	1/2	322601
Tray	20 7/8	12 3/4	5/8	19 3/8	11 3/8	1/2	325301
Tray	21 1/4	15	3/8	18 3/4	14	1/4	330111
Tray	25 3/4	17 7/8	1 1/8	24 3/8	16 1/4	1	332001
Tray	25 3/4	8 3/4	1 1/8	24 3/8	7 1/2	1	333001
Tray	17 3/4	11 3/4	1	16 1/8	10 3/4	7/8	334001
Tray	17 3/4	9	1	16 1/8	7 3/4	7/8	335001
Tray	24	12 5/8	3/4	22 3/4	11 1/4	5/8	337001
Tray	27	12 1/2	3/4	25 3/4	11 1/8	5/8	338001
Tray	16	6	1	14 1/2	4 1/2	7/8	356008
Tray	19 1/2	10 1/2	1 1/4	18 1/2	9 1/2	1 1/8	358108

STANDARD COLORS

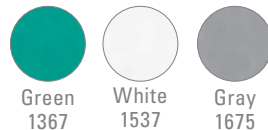

Product Name	Outside Top (inches)			Inside Bottom (inches)			Corner Profile	Model No.
	A	B	C	A	B	C		
Tray	26	26	1 1/4	25 1/8	25 1/8	1	A	601101
Tray	24 1/4	24 1/4	1 7/8	23 1/4	23 1/4	1 3/4	A	602101
Tray	36 1/2	24 3/4	1 1/2	35 1/2	23 1/4	1 3/4	A	603101
Tray	30	30	1 1/4	29 1/8	29 1/8	1 1/8	B	604201
Tray	35 7/8	23 1/2	1 1/2	35	22 5/8	1 3/8	B	605001
Tray	25 1/4	19 1/4	1 1/8	23 1/2	17 1/2	1 1/8	C	606101
Tray	25 3/4	13 5/8	1 1/4	24 1/2	12 3/8	1 1/8	C	607001
Tray	30	20	2	28 5/8	18 5/8	1 7/8	C	608101
Tray	47 5/8	23 7/8	2 1/4	46 3/4	22 7/8	2	B	609001
Tray	36 1/2	17 1/2	1 5/8	35 5/8	16 5/8	1 1/2	A	610001
Tray	24 1/4	20 1/4	1 1/2	23 3/8	19 3/8	1 3/8	A	611001
Tray	28	28	1 1/2	27 1/8	27 1/8	1 3/8	B	612001
Tray	39 1/2	19 1/2	2	38 5/8	18 5/8	1 7/8	D	614001
Tray	30	26	1 1/4	29 1/8	25 1/8	1 1/8	A	615001
Tray	30 1/2	24 1/2	1 7/8	29 5/8	23 5/8	1 5/8	A	617001
Tray	39	19	2	38 1/8	18 1/8	1 7/8	B	618001
Tray	40	28	1 1/2	39 1/8	27 1/8	1 3/8	B	619001
Tray	32	18	1 1/4	31 1/8	17 1/8	1 1/8	B	620001
Tray	30	28	1 1/2	29 1/8	27 1/8	1 3/8	B	621001
Tray	20 5/8	16 5/8	1 1/2	18 1/8	14 1/8	1 3/8	C	622001
Tray	24 1/4	20 1/4	1 1/8	23 1/4	19 1/4	1	C	626001
Tray	31	26	1 5/8	30	24 7/8	1 1/2	D	627001
Tray / drop ends	24 1/4	24 1/4	2 1/4	23 1/4	23 1/4	2 1/8		630101
Tray / drop ends	32 3/4	24 3/4	1 1/2	31 5/8	22 1/2	1 3/8		633001
Tray	20 1/8	11 1/4	5/8	18 1/8	10	3/8		801111

STANDARD COLORS

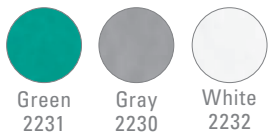

Product Name	Outside Top (inches)			Inside Bottom (inches)			Corner Profile	Model No.
	A	B	C	A	B	C		
Tray / drop ends	29 7/8	23 7/8	1 1/2	28 7/8	22 7/8	1 3/8	D	600008
Tray / drop sides	29 7/8	23 7/8	1 1/2	28 7/8	22 7/8	1 7/8	D	600108
Tray / drop sides	23 7/8	14 7/8	1 3/8	22 7/8	13 7/8	1 1/4	D	600208
Tray / drop end	29 7/8	23 7/8	2	28 7/8	22 7/8	1 7/8	D	600308
Tray	7 1/2	7 1/2	1/2	7 3/8	7 3/8	3/8	A	613008
Tray	31	25	2 3/4	29 1/8	23 1/8	2 5/8	D	624008
Tray	22 1/2	14 1/2	2	20 3/8	12 3/8	1 7/8	D	628008
Tray	19 1/2	19 1/2	1 1/4	18 1/2	18 1/2	1 1/8	D	629008
Tray / drop sides	24	12	2 3/4	23 1/8	11 1/8	2 3/4		634008
Tray	22 7/8	15 1/2	1 1/4	21 7/8	14 1/2	1 1/8		636008
Tray	19 1/4	19 1/4	2	17 7/8	17	1 7/8		638008
Tray / drop end	32	24	1 3/4	30	22 1/8	1 5/8		641008
Tray / 4 drop sides	30	24	1 3/8	29 1/4	23 1/8	1 1/4		642008
Tray	16 1/2	12	5/8	15 3/8	10 7/8	3/8		903118
Tray	20 1/2	17	5/8	19 3/8	15 3/4	3/8		919118

STANDARD COLORS

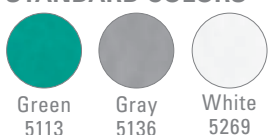

VERSATILE DESIGNS. Accommodates conveyor transport and assembly operations in a wide variety of applications.

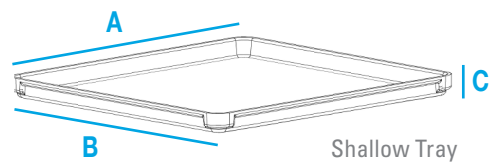

CORNER PROFILES

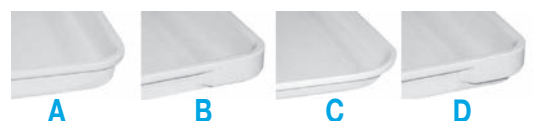

Profiles A and B do not nest or stack. Best used in a rack system or on a conveyor line. Profile C nests partially or completely within another. Profile D stacks.

VENTILATION TRAYS



FUNCTIONAL DESIGN. VERSATILE APPLICATIONS. Expressly designed to facilitate parts drying by encouraging airflow across their low-profile sides.

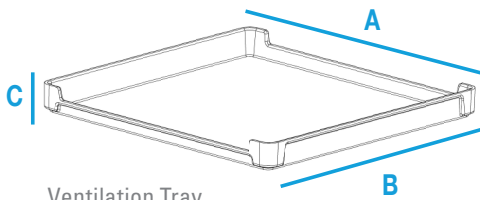

Ventilation Tray



Stacking Boxes with Drop Sides
Model No. 805208
White



Stacking Box with Drop Ends and Sides
Model No. 805508
White



Trays with Drop Ends
Model No. 805508
Gray

- » Stacking ventilation trays optimize air flow and reduce drying/cooling times
- » Variety of depths offered to accommodate a range of part sizes
- » Inherent strength enables trays to be stacked without bending or sagging
- » High operating temperatures -60° to 250°F (-51° to 121°C)

Product Name	Outside Top (inches)			Inside Bottom (inches)			Model No.
	A	B	C	A	B	C	
Stacking Box, vent	21 3/8	21 3/8	2	20 3/8	20 3/8	1 7/8	203108
Stacking Box, vent	21 3/8	21 3/8	3 1/8	20 3/8	20 3/8	3 1/8	203208
Tray / drop ends	29 7/8	23 7/8	1 1/2	28 7/8	22 7/8	1 3/8	600008
Tray / drop sides	29 7/8	23 7/8	1 1/2	28 7/8	22 7/8	1 7/8	600108
Tray / drop sides	23 7/8	14 7/8	1 3/8	22 7/8	13 7/8	1 1/4	600208
Tray / drop end	29 7/8	23 7/8	2	28 7/8	22 7/8	1 7/8	600308
Tray / drop end	29 7/8	23 7/8	1	28 7/8	23 7/8	7/8	600408
Tray / drop ends	24 1/4	24 1/4	2 1/4	23 1/4	23 1/4	2 1/8	630101
Tray / drop ends	32 3/4	24 3/4	1 1/2	31 5/8	22 1/2	1 3/8	633001
Tray / drop sides	24	12	2 3/4	23 1/8	11 1/8	2 3/4	634008
Tray / drop end	32	24	1 3/4	30	22 1/8	1 5/8	641008
Tray / drop ends & sides	30	24	1 3/8	29 1/4	23 1/8	1 1/4	642008
Stacking Box, drop sides	30 3/8	15 7/8	2 7/8	29 1/4	15 1/8	2 5/8	805208
Stacking Box, drop sides	30 3/8	15 7/8	4 1/8	29 5/8	15 1/8	4	805308
Stacking Box, drop ends & sides	30 3/8	15 7/8	2 7/8	29 7/8	15 1/8	2 5/8	805508
Stacking Box, drop sides	31 7/8	15	2	31	14 1/8	1 7/8	816001
Stacking Box, drop sides	25 3/4	17 3/4	3	23 7/8	15 7/8	2 7/8	870308

STANDARD COLORS

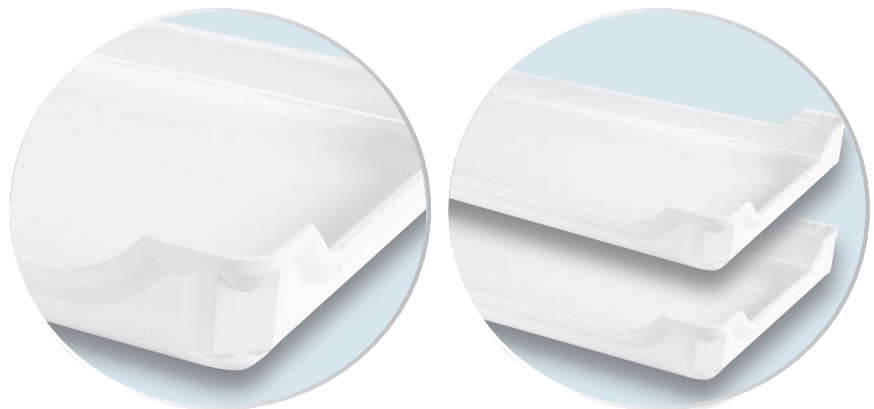
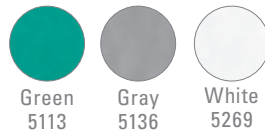

DESIGNED FOR AIRFLOW. Ventilation Trays come in depths of 1 inch up to 4 1/8. We also offer the option to customize and will work with you to design a tray to fit your specific needs.

HOPPERS

- » Bin and hopper box designs server as ideal storage containers for small parts, components, and prepackage goods
- » Composite material won't corrode, bend or potentially contaminate product

Product Name	Outside Top (inches)			Inside Bottom (inches)			Model No.
	A	B	C	A	B	C	
Stacking Hopper Box	24	10	8	18 ³ / ₄	8 ¹ / ₈	7 ⁷ / ₈	842008
Hopper Front	10	6	2 ⁷ / ₈	9	5 ¹ / ₂	2 ³ / ₄	510108
Lid for 510108	6 ² / ₅	6					510118
Hopper Front	19 ³ / ₄	6	2 ⁷ / ₈	18 ³ / ₄	5 ¹ / ₂	2 ³ / ₄	510208
Lid for 510208	16 ³ / ₈	6					510218

STANDARD COLORS

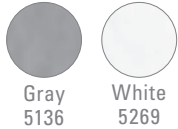

SMART STORAGE. Canted fronts facilitate easy access to parts, stacking design conserves valuable work space.

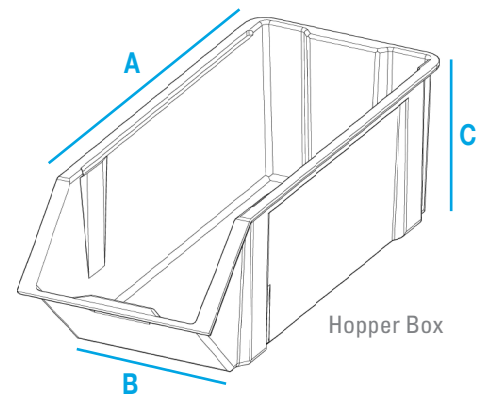

Hoppers Front
Model No. 510108 with
Model No. 510118 Lid
Gray

Hoppers Front
Model No. 510208
White

Hoppers Front
Model No. 510208
White

Stacking Hopper Boxes
Model No. 842008
Gray

CUSTOMIZED TRAYS AND FABRICATION OPTIONS



DESIGNED BY YOU. Got a specific need? No worries! Call our design team today to get your custom fabrication project started today. (Trays and boxes shown in a custom color.)

- » Fabricated slots and holes can be added to trays and containers to secure parts for assembly
- » Sides or drop handles can be added for ease of transport and stacking
- » Divider sets are ideal for part and component organization
- » Labeling and silk screening of containers is available to identify parts and/or departments
- » Various sizes and thickness of flat sheet are available
- » Handhold options includes recesses, cut-outs, and reinforced handles



Custom Dividers, Drain Holes, and Slots



Custom Holes



Custom Drop Handles

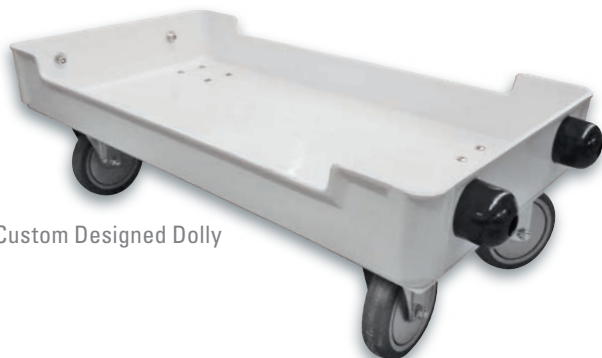

Custom Designed Dolly



Custom Flat Sheets

ULTRA-LITE TOTES AND CONTAINERS

The ULTRA-LITE composite material was developed to meet the customer demand for a lighter, sustainable container that withstands continuous industrial use. The MFG Tray ULTRA-LITE composite is 40% lighter than standard fiberglass while retaining our trusted strength and durability.

- » 40% lighter than standard products with trusted strength and durability
- » Lighter for more ergonomic handling and reduced shipping weight
- » Impervious to cutting oils detergents, mild acids, and alkaline solutions
- » High operating temperatures -60° to 250°F (-51° to 121°C)

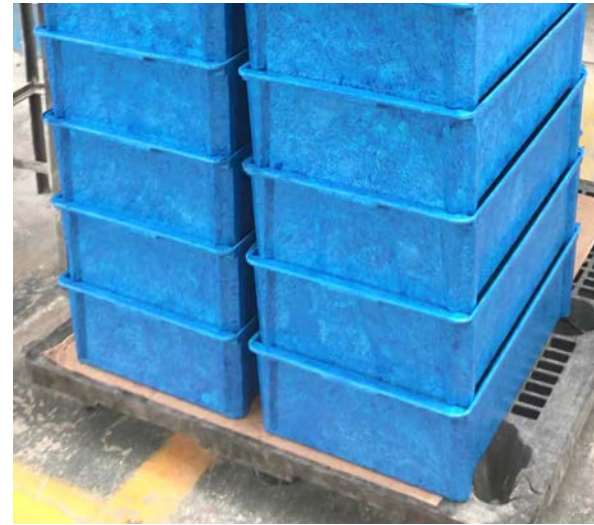

LIGHTER WEIGHT, LEGENDARY STRENGTH. Designed to compete head-on with our legendary product line. Lighter in overall load, with the strength that MFG Tray is known for.

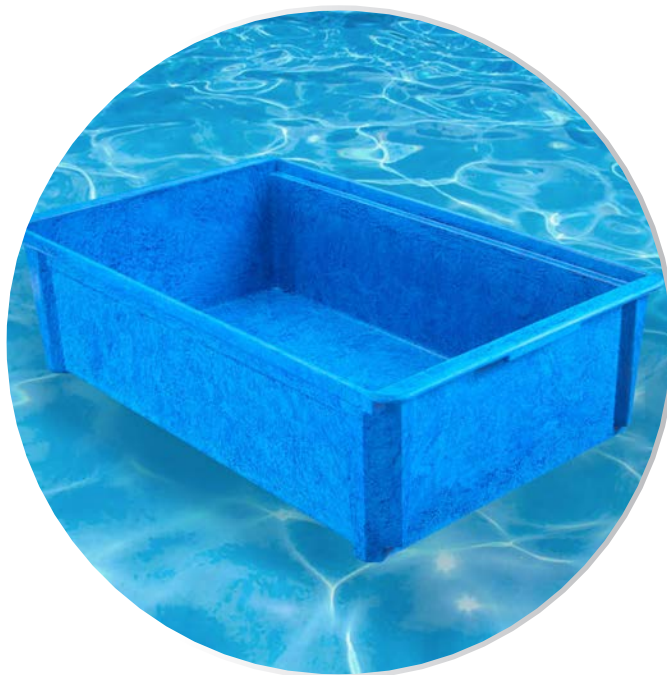

FEEL THE DIFFERENCE. The reinforced ULTRA-LITE composites bring a new level of performance to material handling that you can feel. Available on a variety of MFG products. (Shown: Model No. 705408.)



ULTRA-LITE Container
Model No. 705408
Green



ULTRA-LITE Tote
Model No. 894008
Red



ULTRA-LITE Tote
Model No. 929008
Blue

MANUFACTURING SOLUTIONS USING COMPOSITE MATERIALS

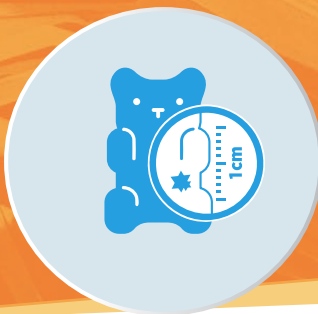

X-Dect™ COMPOSITE MATERIAL

- » X-Ray detectable material
- » Product recall and shipping protection
- » Contaminant detection down to 1 cubic mm components
- » Available on a variety of MFG products

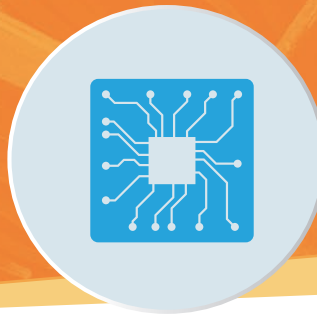

FIBRESTAT COMPOSITE MATERIAL

- » ESD Safe material
- » ANSI/ESD S20.20 standard for ESD protection
- » Surface resistivity of 10^5 to 10^{11} ohms/square
- » pH rating from 3.0 to 10.0
- » Available on a variety of MFG products



VERTICAL FARMING HYDROPONICS

- » Customizable solutions for your farm system
- » Increase dry room efficiency
- » Resists odors, chemicals, and mildew
- » Won't bend, dent, or corrode
- » Wide variety of designs



CALL US FOR YOUR NEXT PROJECT

- » Our team enjoys developing customized solutions for tough material handling challenges and applications
- » Contact our friendly team to discuss any unique design or requirements

Reinforced composites bring a new level of performance to material handling. Our trays and containers will work harder, and smarter for you. Trust MFG Tray for your tough jobs.





MFGT-MH-XX-08/2020

Order From
Dick Jones Sales, Inc.
PO Box 141
Hanover, PA 17331
P 800-441-9955
F 800-253-4036
Email: dickjones@dickjonesales.com



WARNING: This product can expose you to styrene, a chemical known to the State of California to cause cancer. For more information go to www.P65Warnings.ca.gov.