

LIFT TABLES



SOUTHWORTH

Southworth

The Lift Table Experts

Southworth was founded in 1890 and for the last 60 plus years has been in the business of helping companies handle materials faster, safer and easier.

Today, Southworth is the world's leading supplier of vertical movement and positioning equipment with the broadest product lines, largest inventory of stock models, most flexible range of modification, most experienced custom designers and the industry's leading innovator.

In this catalogue, you will find specification information for various designs of scissor lifts and accessories.

Hydraulic and Pneumatic Lift Tables

Pallet Jack Accessible Lift Tables

Lite Capacity Lift Tables

Roll-Handling Lift Tables

Coil-Handling Lift Tables

Dock Lifts

Manual /Power Driven Portable Lifts

Lifts with Turntables

Lift and Tilt Tables

Carousel Lifts



Coil Handling

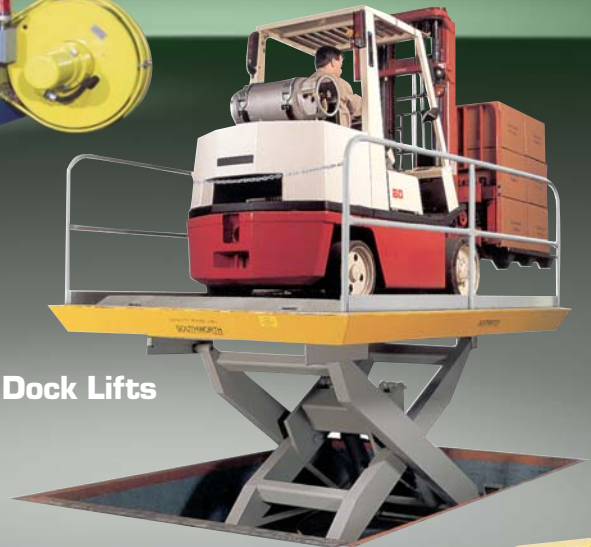

Dock Lifts



Stainless Steel Lifts



Lift and Tilt



**Lift Table with
Flush Mount Turntable**

Quality Features

For Reliable Performance and Long Service Life



Contoured Legs

With extra width at the pivot point, Southworth's contoured legs combine great strength with lower collapsed height.



Lubricated-for-Life Bushings

All pivot points have hardened pins that operate in lubricated-for-life, virtually maintenance-free bushings.



Heavy-Duty Hoses

All Southworth lifts have heavy-duty hoses with burst strength 600% greater than the hydraulic operating pressure.



Oversize, Low-Pressure Hydraulic Cylinders

Low operating pressure extends the life of hydraulic components. Chrome-plated piston rods are corrosion resistant, and cylinder walls are honed.



Built In Safety Chock

Prevents accidental lowering of table during maintenance.



Comfort Edge Design

No sharp corners on table top. Bright safety yellow stripe for high visibility.



Heavy-Duty Torque Tubes

Torque tubes minimize platform twisting and deflection for high degree of rigidity and stability.



Tell-Tale Return Hydraulic Fluid Line

Clear plastic return line from cylinder rod bearing to tank gives visual indication of need to repack cylinder and prevents fluid spillage in the event of a bypass.



Adjustable Flow Control

Pressure compensated flow control valve with lock out. Preset and locked at 10 F.P.M. maximum lowering speed per ANSI Standard, MH29 where applicable.

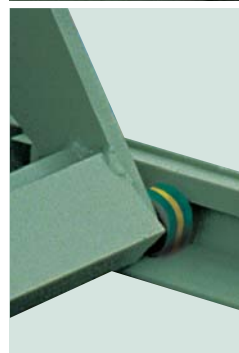

Wear Indicating Rollers and Roll Retainers

Rollers are captured in the base by means of retainers to prevent accidental separation or misalignment. All oversized width tabletops also include an upper set of retainers.

Southworth Scissors Lifts are designed and manufactured to meet or exceed ANSI MH29.1 Safety Requirements for Industrial Scissors Lifts.

Backsaver® Lifts **and Backsaver Lite Lifts**

LS Series Backsaver® Lifts

Southworth Backsaver® Lifts are extremely rugged and reliable machines. Thousands of Backsaver Lifts are in use throughout the United States for machine feeding, work positioning, assembly, order picking, pallet loading, and a wide range of other applications. They are available in many basic sizes and capacities to lift and position loads up to 6,000 lbs and heights to 56". The wide range of power options, controls, tabletops, and base configurations that can be specified for each of the many basic sizes gives the user an almost unlimited choice of variations.

Backsaver Lite Lifts

These industrial grade lift tables are specifically designed for those applications involving lighter loads of up to 1,500 lbs. They are available in four standard configurations: Stationary, Compact with high lift and small footprint, Portable with easy rolling casters, and Powered Portable with battery powered drive.

Stainless Steel Models



Semi-Live Portable



Backsaver Lift



Backsaver Lite Powered Portable



Backsaver Lite Portable



Backsaver Lite Compact

Backsaver Lite

	Model No.	Capacity (Lbs.)	Vertical Travel (Inches)	Height		Standard Platform (Inches)	Maximum Platform (Inches)	Elevating Time (Seconds)	HP	Standard Voltage	Approx. Shipping Weight/Lbs. (std. platform)	
				Min. (Inches)	Max. (Inches)							
QUICK SHIP MODELS	LL & LS Series Backsaver Lite Lifts											
	LL05.5-26	550	26	5 ½	31½	20 x 36	36 x 60	9	½	115/1/60	240	
	LL1.1-26	1100	26	5 ½	31½	20 x 36	36 x 60	21	½	115/1/60	255	
	LL1.5-35	1500	35	6 ¼	41 ¼	24 x 48	36 x 60	32	½	115/1/60	450	
	CLL05.5-26	550	26	9	35	24 x 40	30 x 48	7	½	12 volt DC	315	
	CLL1.1-26	1100	26	9	35	24 x 40	30 x 48	13	½	12 volt DC	325	
	LS05-30	500	30	6	36	12 x 24	12 x 24	20	½	115/1/60	175	
	LS05-30W	500	30	6	36	16 x 24	24 x 36	20	½	115/1/60	200	
	LS1-30	1000	30	6	36	16 x 24	24 x 36	20	½	115/1/60	225	
		LS Series Backsaver Lifts										
	LS2-24	2000	24	6%	30%	24 x 36	48 x 60	14	1	115/1/60	500	
	LS4-24	4000	24	6%	30%	24 x 36	48 x 60	28	1	115/1/60	550	
	LS6-24	6000	24	7%	31%	24 x 36	48 x 60	44	1	115/1/60	600	
	LS2-36	2000	36	6%	42%	24 x 48	48 x 72	21	1	115/1/60	600	
	LS4-36	4000	36	6%	42%	24 x 48	48 x 72	42	1	115/1/60	650	
	LS6-36	6000	36	7%	43%	24 x 48	48 x 72	22	3.2	460/3/60	725	
	LS2-48	2000	48	8	56	24 x 66	48 x 96	9	3.2	460/3/60	950	
	LS4-48	4000	48	8	56	24 x 66	48 x 96	18	3.2	460/3/60	1000	
	LS6-48	6000	48	8	56	24 x 66	48 x 96	27	3.2	460/3/60	1050	
	LS2-24W	2000	24	6%	30%	36 x 36	60 x 60	14	1	115/1/60	575	
	LS4-24W	4000	24	6%	30%	36 x 36	60 x 60	28	1	115/1/60	625	
	LS6-24W	6000	24	7%	31%	36 x 36	60 x 60	44	1	115/1/60	675	
	LS2-36W	2000	36	6%	42%	36 x 48	60 x 72	21	1	115/1/60	700	
	LS4-36W	4000	36	6%	42%	36 x 48	60 x 72	42	1	115/1/60	750	
	LS6-36W	6000	36	7%	43%	36 x 48	60 x 72	22	3.2	460/3/60	825	
	LS2-48W	2000	48	8	56	48 x 66	72 x 96	9	3.2	460/3/60	1150	
	LS4-48W	4000	48	8	56	48 x 66	72 x 96	18	3.2	460/3/60	1200	
	LS6-48W	6000	48	8	56	48 x 66	72 x 96	27	3.2	460/3/60	1250	
	LS Series Plus Lifts											
	LS8-36	8000	36	9	45	30 x 60	54 x 84	21	3.2	460/3/60	1350	
	LS10-36	10000	36	10	46	30 x 60	54 x 84	28	3.2	460/3/60	1400	
	LS12-36	12000	36	10	46	30 x 60	54 x 84	28	3.2	460/3/60	1500	
	LS3-42	3000	42	6%	48%	24 x 56	48 x 84	49	1	460/3/60	725	
	LS5-42	5000	42	7	49	24 x 56	48 x 84	74	1	460/3/60	775	
	LS8-48	8000	48	9	57	24 x 66	48 x 96	30	3.2	460/3/60	1600	
	LS2-60	2000	60	10	70	24 x 86	48 x 120	10	3.2	460/3/60	1300	
	LS4-60	4000	60	10	70	24 x 86	48 x 120	20	3.2	460/3/60	1375	
	LS5-60	5000	60	8	68	24 x 86	48 x 120	29	3.2	460/3/60	1450	
	LS6-60	6000	60	10	70	24 x 86	48 x 120	30	3.2	460/3/60	1450	
	LS8-60	8000	60	10	70	24 x 86	48 x 120	42	3.2	460/3/60	1700	
	LS2-72	2000	72	10	82	30 x 102	60 x 132	19	3.2	460/3/60	2000	
	LS4-72	4000	72	10	82	30 x 102	60 x 132	38	3.2	460/3/60	2100	
	LS6-72	6000	72	12	84	30 x 102	60 x 132	41	3.2	460/3/60	2200	
	LS2-84	2000	84	10	94	30 x 120	60 x 156	26	3.2	460/3/60	2200	
	LS4-84	4000	84	10	94	30 x 120	60 x 156	52	3.2	460/3/60	2300	
	LS6-84	6000	84	14	98	30 x 120	60 x 156	56	3.2	460/3/60	2500	
	LS Series Wide Base Lifts											
	LS8-36W	8000	36	9	45	42 x 60	66 x 84	21	3.2	460/3/60	1500	
	LS10-36W	10000	36	10	46	42 x 60	66 x 84	28	3.2	460/3/60	1600	
	LS12-36W	12000	36	10	46	42 x 60	66 x 84	28	3.2	460/3/60	1700	
	LS3-42W	3000	42	6%	48%	42 x 56	66 x 84	49	1	460/3/60	875	
	LS5-42W	5000	42	7	49	42 x 56	66 x 84	74	1	460/3/60	925	
	LS8-48W	8000	48	9	57	48 x 66	72 x 96	30	3.2	460/3/60	1800	
	LS2-60W	2000	60	10	70	54 x 86	84 x 120	20	3.2	460/3/60	1650	
	LS4-60W	4000	60	10	70	54 x 86	84 x 120	20	3.2	460/3/60	1725	
	LS5-60W	5000	60	8	68	54 x 86	84 x 120	29	3.2	460/3/60	1800	
	LS6-60W	6000	60	10	70	54 x 86	84 x 120	30	3.2	460/3/60	1800	
	LS8-60W	8000	60	10	70	54 x 86	84 x 120	42	3.2	460/3/60	2150	
	LS2-72W	2000	72	10	82	60 x 102	96 x 132	24	3.2	460/3/60	2450	
	LS4-72W	4000	72	10	82	60 x 102	96 x 132	38	3.2	460/3/60	2550	
	LS6-72W	6000	72	12	84	60 x 102	96 x 132	41	3.2	460/3/60	2700	
	LS2-84W	2000	84	10	94	60 x 120	96 x 156	35	3.2	460/3/60	2750	
	LS4-84W	4000	84	10	94	60 x 120	96 x 156	52	3.2	460/3/60	2850	
	LS6-84W	6000	84	14	98	60 x 120	96 x 156	56	3.2	460/3/60	3100	

Lifts with 3.2 HP three-phase power units available with 1 HP single-phase power units. Rise time increases by a multiplier of 3.3.

Heavy-Duty DL Series Lifts, L Series Cam Lifts and Tandem Lifts (Long and Wide Base)

DL Series Lifts

These heavy-duty lifts are ideal for cargo handling and lifting heavy industrial loads. Built-in hydraulic overload relief protects personnel and structures. Heavy-plate platforms with structural reinforcement minimize deflection while the wide base provides increased rigidity and stability.

L Series Cam Lifts

Exclusive CAM design provides maximum capacities (up to 30,000 lbs.) with minimum height clearances.

Tandem Lifts

LST Tandem lifts provide level rise for long loads such as lumber, pipes, sheets, bar stock, and assemblies. These lifts are typically used as feeding tables for tube welders, formers, and panel saws as well as for bundling and banding bar stock, lumber, and other materials.

Tandem design allows the combination of high capacity and low collapsed height to support loads up to 7' x 17'. They are available in extra long and extra wide configurations.

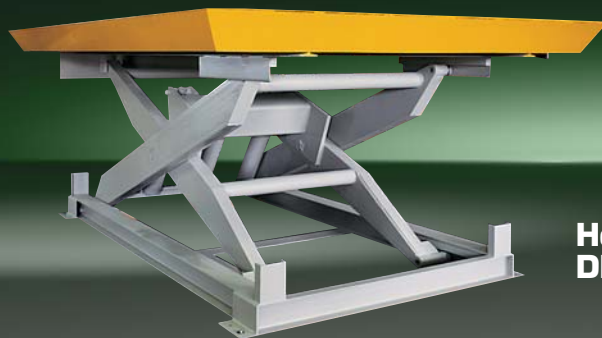

**Heavy-Duty
DL Series Lifts**



L Series Cam Lifts



Tandem Lifts

DL Series Heavy-Duty Lifts

Model No.	Capacity (Lbs.)	Vertical Travel (Inches)	Height		Standard Platform (Inches)	Maximum Platform (Inches*)	Top Plate Thickness	Elevating Time (Seconds)	HP	Standard Voltage	Approx. Shipping Weight/Lbs. (std. platform)
			Min. (Inches)	Max. (Inches)							
DL20-36	20000	36	16	52	60 x 76	96 x 108	½	56	3.2	460/3/60	4000
DL10-48	10000	48	13¼	61¼	47 x 76	84 x 108	¾	56	3.2	460/3/60	3300
DL15-48	15000	48	14¼	62¼	60 x 76	96 x 108	½	62	3.2	460/3/60	4000
DL25-48	25000	48	16	64	60 x 76	96 x 108	½	85	3.2	460/3/60	4800
DL10-60	10000	60	16	76	60 x 102	96 x 144	¾	48	3.2	460/3/60	4800
DL12-60	12000	60	16	76	60 x 102	96 x 144	¾	52	3.2	460/3/60	5100
DL16-60	16000	60	16	76	60 x 102	96 x 144	½	72	3.2	460/3/60	5300
DL20-60	20000	60	22	82	60 x 120	96 x 144	½	86	3.2	460/3/60	6800
DL25-60	25000	60	26	86	72 x 144	108 x 180	½	105	3.2	460/3/60	10500
DL20-72	20000	72	22	94	72 x 144	108 x 180	½	112	3.2	460/3/60	9700
DL4-84	4000	84	12	96	60 x 120	96 x 156	¾	45	3.2	460/3/60	4200
DL6-84	6000	84	16	100	60 x 120	96 x 156	¾	48	3.2	460/3/60	5000
DL10-84	10000	84	16	100	60 x 120	96 x 156	¾	88	3.2	460/3/60	5800

*Maximum platforms are for reasonably uniform loads.

L Series CAM Lifts

Model No.	Capacity (Lbs.)	Vertical Travel (Inches)	Height		Standard Platform (Inches)	Maximum Platform (Inches)	Frame Size (Inches)	Elevating Time (Seconds)	HP	Standard Voltage	Approx. Shipping Weight/Lbs. (std. platform)
			Min. (Inches)	Max. (Inches)							
L8-36	8000	36	7%	43%	30 x 60	48 x 78	28½ x 60	21	3.2	460/3/60	1360
L10-36	10000	36	9	45	32 x 60	54 x 78	30¾ x 60	31	3.2	460/3/60	1800
L15-36	15000	36	9½	45½	36 x 72	60 x 90	34½ x 70½	50	3.2	460/3/60	2900
L20-36	20000	36	10½	46½	36 x 72	60 x 90	34½ x 70½	50	3.2	460/3/60	3300
L30-36	30000	36	11½	47½	43 x 72	72 x 96	41 x 70½	56	5.0	460/3/60	4400

LST Series Tandem Lifts

Model No.	Capacity (Lbs.)	Vertical Travel (Inches)	Height		Standard Platform (Inches)	Maximum Platform (Inches)	Elevating Time (Seconds)	HP	Standard Voltage	Approx. Shipping Weight/Lbs. (std. platform)
			Min. (Inches)	Max. (Inches)						
LST 4-36	4000	36	6%	42%	24 x 96	48 x 120	42	1	115/1/60	1150
LST 8-36	8000	36	6%	42%	24 x 96	48 x 120	84	1	115/1/60	1250
LST 12-36	12000	36	7¼	43¼	24 x 96	48 x 120	44	3.2	460/3/60	1400
LST 4-48	4000	48	8	56	24 x 132	48 x 168	18	3.2	460/3/60	1850
LST 8-48	8000	48	8	56	24 x 132	48 x 168	36	3.2	460/3/60	1950
LST 12-48	12000	48	8	56	24 x 132	48 x 168	54	3.2	460/3/60	2050
LST 4-60	4000	60	10	70	24 x 172	48 x 204	20	3.2	460/3/60	2550
LST 8-60	8000	60	10	70	24 x 172	48 x 204	40	3.2	460/3/60	2700
LST 10-60	10000	60	8	68	24 x 172	48 x 204	58	3.2	460/3/60	2850
LST 12-60	12000	60	10	70	24 x 172	48 x 204	60	3.2	460/3/60	2850

LST Series Wide Base Lifts

Model No.	Capacity (Lbs.)	Vertical Travel (Inches)	Height		Standard Platform (Inches)	Maximum Platform (Inches)	Elevating Time (Seconds)	HP	Standard Voltage	Approx. Shipping Weight/Lbs. (std. platform)
			Min. (Inches)	Max. (Inches)						
LST 4-36W	4000	36	6%	42%	36 x 96	60 x 120	42	1.0	115/1/60	1350
LST 8-36W	8000	36	6%	42%	36 x 96	60 x 120	84	1.0	115/1/60	1450
LST 12-36W	12000	36	7¼	43¼	36 x 96	60 x 120	44	3.2	460/3/60	1600
LST 4-48W	4000	48	8	56	48 x 132	72 x 168	18	3.2	460/3/60	2250
LST 8-48W	8000	48	8	56	48 x 132	72 x 168	36	3.2	460/3/60	2350
LST 12-48W	12000	48	8	56	48 x 132	72 x 168	54	3.2	460/3/60	2450
LST 4-60W	4000	60	10	70	54 x 172	84 x 204	40	3.2	460/3/60	3250
LST 8-60W	8000	60	10	70	54 x 172	84 x 204	40	3.2	460/3/60	3400
LST 10-60W	10000	60	8	68	54 x 172	84 x 204	58	3.2	460/3/60	3550
LST 12-60W	12000	60	10	70	54 x 172	84 x 204	60	3.2	460/3/60	3550

Lifts with 3.2 HP three-phase power units available with 1 HP single-phase power units. Rise time increases by a multiplier of 3.3. The listings above represent Southworth's most popular tandem lift arrangements, however, practically any lift models can be tandemized end to end or side by side

Spacesaver® High Rise Lifts and Specialty Lift Tables

Spacesaver® Lifts

LSH Spacesaver® lifts can be used as personnel work platforms, as cargo lifts, between levels as mezzanine lifts, and for positioning test apparatus or tools. These lifts are available with vertical travel up to 12 feet. Capacities range from 1,000 to 12,000 pounds.

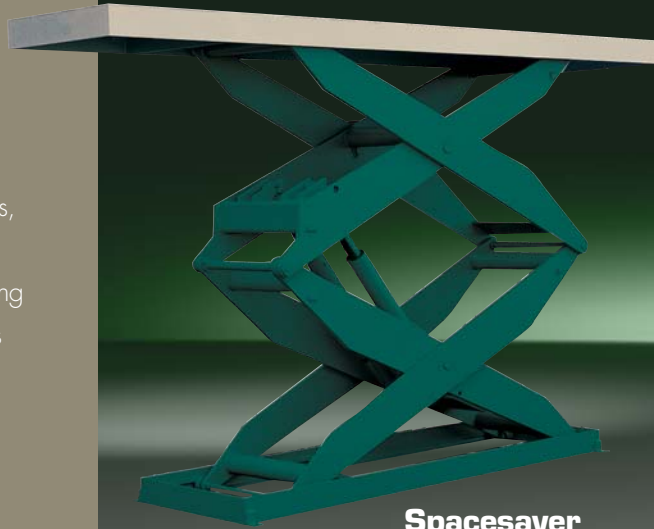

Spacesaver Lifts

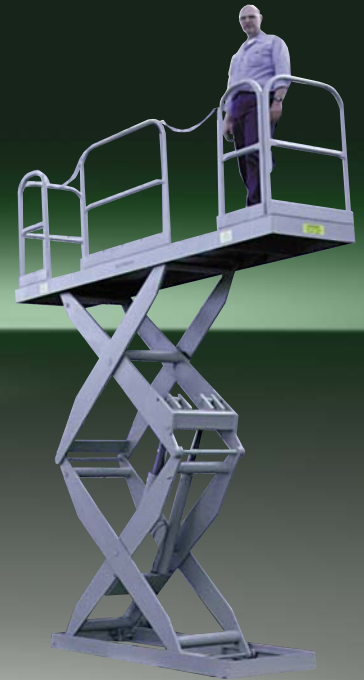

Personnel Lifts

Floor Height Lifts

These lift tables lower to floor height or near floor height so that they can be fed and offloaded by hand pallet trucks. Standard capacities range from 500 to 6,000 pounds.



Floor Height Lifts

Pneumatic Lifts

For use anywhere that shop air is available. Capacities up to 4,000 pounds. No hydraulic fluid means no risk of contaminants in the production process.

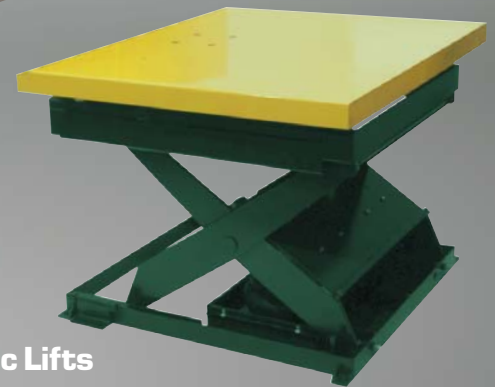

Pneumatic Lifts

Lifts for Palletizing

Southworth manufactures a wide variety of Lift Tables for use in palletizing applications. See our Pallet Handling Brochure for a complete selection.

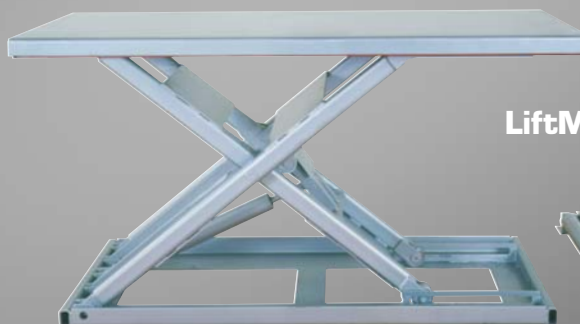

LiftMat Series

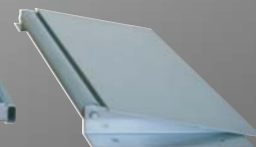

LSH Series Spacesaver High Rise Lifts

Model No.	Capacity (Lbs.)	Vertical Travel (Inches)	Height		Standard Platform (Inches)	Maximum Platform (Inches)	Elevating Time (Seconds)	HP	Standard Voltage	Approx. Shipping Weight/Lbs. (std. platform)
			Min. (Inches)	Max. (Inches)						
LSH 1-36	1500	36	10	46	24 x 32	36 x 48	16	1.0	115/1/60	600
LSH 1-48	1000	48	9½	57½	24 x 40	36 x 54	21	1.0	115/1/60	750
LSH 2-48	2000	48	9½	57½	24 x 40	36 x 54	42	1.0	115/1/60	800
LSH 4-48	4000	48	12	60	30 x 42	48 x 60	16	3.2	460/3/60	1250
LSH 6-48	6000	48	14	62	32 x 42**	48 x 60	35	3.2	460/3/60	1300
LSH 1-60	1000	60	10½	70½	24 x 48	36 x 60	27	1½	115/1/60	750
LSH 2-64	2500	64	12½	76½	24 x 53	42 x 66	16	3.2	460/3/60	1100
LSH 5-60	5000	60	14	74	30 x 53	48 x 66	30	3.2	460/3/60	1800
LSH 8-60	8000	60	14	74	30 x 54	48 x 66	43	3.2	460/3/60	1900
LSH 12-60	12000	60	18	78	36 x 67	60 x 84	95	3.2	460/3/60	3200
LSH 1-72	1500	72	12½	84½	20 x 53	36 x 66	58	1½	115/1/60	900
LSH 2-72	2000	72	12½	84½	20 x 53	36 x 66	75	1½	115/1/60	950
LSH 5-72	5000	72	14	86	32 x 57**	54 x 72	36	3.2	460/3/60	2000
LSH 2-84	2000	84	17	101	33 x 69	60 x 90	29	3.2	460/3/60	1900
LSH 4-84	4000	84	17	101	33 x 69	60 x 90	34	3.2	460/3/60	2200
LSH 6-84	6000	84	17	101	33 x 69	60 x 90	62	3.2	460/3/60	2350
LSH 1-96†	1000	96	17¼	113¼	24 x 53	42 x 66	17	3.2	460/3/60	1600
LSH 3-96	3000	96	17	113	36 x 77	60 x 108	50	3.2	460/3/60	3000
LSH 5-96	5000	96	17	113	36 x 77	60 x 108	64	3.2	460/3/60	3500
LSH 10-96	10000	96	20	116	36 x 77	60 x 108	102	3.2	460/3/60	4500
LSH 2-114	2000	114	17	131	33 x 88	60 x 108	36	3.2	460/3/60	3400
LSH 5-120*	5000	120	24	144	44 x 69***	72 x 96	102	3.2	460/3/60	4800
LSH 3-128	3000	128	21	149	42 x 96	72 x 120	48	3.2	460/3/60	3400
LSH 6-128	6000	128	21	149	42 x 96	72 x 120	80	3.2	460/3/60	3500
LSH 2-144*	2000	144	24	168	42 x 77	72 x 108	68	3.2	460/3/60	4350
LSH 4-144*	4000	144	24	168	42 x 77	72 x 108	136	3.2	460/3/60	4500
LSH 5-144	5000	144	21	165	42 x 108	72 x 144	125	3.2	460/3/60	4000

† 1¼" Lateral motion

*Three sets of legs—All others have two

** Base frame width 30

***Base frame width 42

ZLS Series Floor Height Lift Tables

Model No.	Capacity (Lbs.)	Vertical Travel (Inches)	Overall Width	Inside Width	Platform Length	Side Height	Deck Thickness	Standard Platform (Inches)	Elevating Time (Seconds)	HP	Standard Voltage	Approx. Shipping Weight/Lbs. (std. platform)
ZLS2-35	2000	35"	49 - 67¼"	32-50"	48"	7¼"	¾"	50 x 48"	45	1	115/1/60	1425
ZLS4-35	4000	35"	49 - 67¼"	32-50"	48"	7¼"	¾"	50 x 48"	48	1	115/1/60	1440
ZLS6-34	6000	34"	53 - 71¼"	32-50"	48"	8¼"	½"	50 x 48"	63	1	115/1/60	1865

LiftMat Series

Model No.	Capacity (Lbs.)	Vertical Travel (Inches)	Low Height (Inches)	Raised Height (Inches)	Standard Platform (Inches)	Maximum Platform (Inches)	Elevating Time (Seconds)	HP	Standard Voltage	Approx. Shipping Weight/Lbs. (std. platform)
LM-05	500	32"	3"	35"	24 x 66"	48 x 96"	15	1	115/1/60	540
LM1	1000	32"	3"	35"	24 x 66"	48 x 96"	15	1	115/1/60	560
LM2	2000	31½"	3½"	35"	24 x 66"	48 x 96"	20	1	115/1/60	600

Pneumatic Lifts

Model No.	Capacity (Lbs.)	Vertical Travel (Inches)	Low Height (Inches)	Raised Height (Inches)	Standard Platform (Inches)	Maximum Platform (Inches)	Elevating Time (Seconds)	Air (PSI) Free Air	Approx. Shipping Weight/Lbs. (std. platform)
LSA2-24	2000	24	7 ½"	31 ½"	26" x 48"	48" x 72"	15 (empty)	80 psi/15 cfm	650
LSA4-24	4000	24	8"	31 ½"	42" x 48"	66" x 72"	15 (empty)	80 psi/15 cfm	800

Lift Tables Options and Accessories

Popular Lift Table Options and Accessories

When you purchase a Southworth Lift Table, you get exactly what you want, without any compromise.

Southworth's standard line of lift tables offer well over one million different configurations that meet the vast majority of application needs. In addition, the wide range of options and accessories shown in this brochure allow you to specify tables that precisely meet your lifting and positioning needs.

Your Southworth distributor will be happy to assist you in selecting options and accessories to meet your specific application.

One Touch /Auto Level

Raise or lower the lift a preset increment at the touch of a button. User Programmable.

Toe Sensing Edge

Sensor automatically reverses lowering motion on contact.

Flush Mount Turntables

are only $\frac{3}{16}$ " higher than the surrounding platform. Turntable is rotationally locked when the lift is in the full down position.

Wheels and Casters

for a variety of portability requirements including powered and semi-portable to suit any environment.

Bellows Skirting

cover mechanism between platform and base. Protects vital lift or tilter components from damage caused by debris.



Popular Lift Table Options for:

- Control
- Safety
- Convenience
- Portability
- Machine Protection



Hydraulic / Actuation Options



Larger Power Units*
Higher horsepower motors and hydraulics used to increase travel speed.



Manual Hand or Foot Pump Actuation
Lever type hand pump or foot pedal pump for use when manual actuation or precise positioning is required.



Minimum Downdrift Valving*
Near positive shut-off valving for use where platform must maintain position for extended periods of time.



Continuous Duty Power Units*
Specially designed power units with motors capable of many motor starts per hour.



Air Motor Driven Power Units
For use where electrical actuation is undesirable and shop air is available; meets explosion proof requirements.



Cross Check Valving*
Locks oil in cylinders to eliminate deflection caused by oil transfer. Used in certain side loading applications.



Continuous Running Power Units*
Heavy-duty power units with special cooling features. Power unit runs continuously, and valves are actuated to activate lift. Used for extremely high jogs or cycles.



Screw Jack*
Lift is actuated by gear motor driven worm or ball screw. For more precise, repetitive positioning or where hydraulics are not desired.



DC Power Units
Direct current power units for use with battery power.



Power Units Full JIC Style Continuous Running Power Units*
Continuous running power unit built to JIC specifications.



Double Acting Cylinders*
For special applications where it is necessary to provide both power up and power down.



Hot and Cold Temperature Hydraulic Packaging
Special sealing and hydraulic fluids for use in hot or cold atmospheres.



External Power Unit*
Power unit is connected to lift only by hydraulic hoses.



No Coast Valving*
Fast acting hydraulic valving, which decreases upward coast, for use where more precise positioning is desired.



Air Bag Actuation
Inflatable air bag provides limited travel lift actuation. Used where electrical power is not desirable or where only two positions are required.



Velocity Fuse(s)/Excess Flow Protectors
Hydraulic control prevents table free fall in the unlikely event of massive hydraulic failure.

Electronic Control Options



Wall Mounted Push Button
Permanent wall mounted controls for use where a fixed operating station is desirable.



Maintained Contact Controls
Up/down/emergency stop push button control which stops travel automatically at preset level. (Control button does not have to be held.)



Special NEMA Rated Electrical Packages*
A variety of electrical packages designed to meet NEMA standards for outdoor, explosion proof, and other installation requirements.



Travel Limit Switch(es)
Electrical switch stops travel, prevents overtravel, provides height positioning, and can activate associated equipment. Should be used with mechanical stop for fixed lowered height.



Automatic Leveling Package
Optical sensing control positions table and stops travel at any preset height.



Electrical Quick Disconnect
Quick disconnect plugs for use with portable or frequently relocated lifts.



Visual or Audible Signals
Lights or bells used to warn personnel when lift is in operation.



One-Touch Auto Leveling
Increase productivity in repositioning applications. Raise or lower lifts a specific increment at the touch of a button.

Mechanical Options



Narrow Base
Reduced width base to fit special needs. Must be lagged for stability.



Lifting Eyes
Steel eye bolts allow table to be lifted with hoist. Frequently used in pit mounted applications for ease of installation and maintenance.



Wide Base
Increased width base provides extra stability for wider loads.



Lag Plates
Permanently attached plates or angles with bolt holes for lagging tables to floor.



Semi-Live Portable
Consists of wheels at one end of base and pull plate at the other, plus wheeled jack handle. Used only for moving table to a new position, and not for transporting materials.



Flanged Wheels
Steel wheels with flange for use with flat or rail track to provide unidirectional horizontal movement.



Sub Bases
Extra base unit increases low height of standard designs. Provides a positive stop at predetermined down level. Frequently used for integration with automated systems.



Increased Roll Over Capacity
Structural strengthening of table support for use in pit installations where loaded trucks or transporters must traverse the platform in its lowered position.



Powered Traverse
Hydraulic motor drives two wheels on a single shaft via a chain and sprocket.



Casters
A variety of casters, mounting arrangements, and floor locks is available for use where full portability and maneuverability are desired.



Vee Groove Wheels
Steel wheels with groove for use with inverted angle or Vee track to provide unidirectional horizontal movement.



Push Bar
Hand held bar to facilitate manual movement of wheeled or castered portable units.

Platform Options



Manual or Powered Turntables
Bearing mounted and supported turntables for rotating or positioning loads of work.



Vee Cradle Platform
Vee shaped platform provides centering and secure handling of cylindrical loads, such as rolls.



End-Shifting Platform
Manual or powered platform end-shift used to align loads with other handling systems or operating equipment.



Gravity or Powered Conveyor Tops
Roller conveyor tops for integration with other handling equipment or systems.



Tilting Tops
30°, 45°, and 90° tilting platforms for better positioning of certain loads.



Fork Pockets
Structural fork pockets allow entire unit to be lifted and moved by fork truck.



Ball Transfer Top
Fixed or retractable ball conveyors for omnidirectional movement of load on platform.



Throw-Over Plates
Hinged plates used to provide a bridge between the platform surface and an adjacent fixed height surface.



Access Plate
Removable or hinged plate in platform surface allows access to power unit and hydraulics when lift is in lowered position.



Stainless Steel Platform
Corrosion and damage resistant surface for use with corrosive materials or where frequent wash down is required.



Fixed and Removable Handrails with Snap Chain
For use in applications involving personnel lifting. Removable rails allow access from any side when lift is not in use.



Bellows Accordion Skirting
Single-ply stitched polyester skirting covers mechanism between platform and base. Also available as boots to cover cylinders only. (See photo on page 10)



Anti-skid Platform Surfaces
Diamond tread platform surface or abrasive type paint provide better traction for powered vehicles and reduce danger of personnel slipping.



Wheel Chock
Counter-weighted wheel chock recessed in table top. Automatically engages as lift raises and prevents wheeled vehicle from rolling in set direction.



Bevel Toe Guard
30° bevel on platform sides provides warning contact without abrupt shear point when lift table is installed in pit.



Toe Sensing Edge
Automatically reverses lift on contact with any obstruction.

Environmental Options



Export Boxing
Meets special packaging and shipping requirements for export out of the United States.



Special Paint
Customer specified paint formulations and colors. Corrosion Protection similar to that of Hot Dip Galvanizing.



Cam Follower Rollers*
Low friction leg rollers for increased efficiency and longer operating life.



High Duty Cycle and Greased Manifolds*
Special bearing packages and regreaseable pivot points for moderately high and high duty cycle applications.

* Because of the high performance of standard tables, most asterisked options may not be required in normal usage. To avoid unnecessary cost, please consult factory before specifying these options.